



**GLOBAL WELLNESS
INSTITUTE™**
EMPOWERING WELLNESS WORLDWIDE

GUIDE TO HYDROTHERMAL SPA & WELLNESS DEVELOPMENT STANDARDS

What You Need to Know Before Building Wet Areas

THIRD EDITION

Guide to Hydrothermal Spa & Wellness Development Standards

What You Need to Know
Before Building Wet Areas

Cassandra Cavanah



**GLOBAL WELLNESS
INSTITUTE™**
EMPOWERING WELLNESS WORLDWIDE

© 2018 by Global Wellness Institute. All rights reserved.

ISBN 978-0-578-17820-2

No part of this book may be reproduced in any form without written permission of the copyright owners. All images in this book have been reproduced with the knowledge and prior consent of the owners and no responsibility is accepted by producer, publisher or printer for any infringement of copyright or otherwise, arising from the contents of this publication. Every effort has been made to ensure that credits accurately comply with information supplied.

First published in the United States of America by the Global Wellness Institute

333 S.E. 2nd Avenue, Suite 3750, Miami, FL 33131

Telephone: +1 (212) 716 1205

www.globalwellnessinstitute.org

Disclaimer

The content of this book is for general information purposes only and has been obtained from many sources, professional organizations, manufacturers' literature and codes. The author and publisher have made every reasonable effort to ensure that this work is accurate and current, but do not warrant, and assume no liability for, the accuracy or completeness of the text or illustrations, or their fitness for any particular purpose. It is the responsibility of the users of this book to apply their professional knowledge to the content, to consult sources referenced, as appropriate, and to consult professionals for expert advice.

Editor: Cassandra Cavanah

Design and illustrations: Amy Detrick

Third Edition 10/2018

Second Edition 10/2016

First Edition published 09/2014

Contents

Foreword	V
Introduction	VII
Chapter One: Overview of Hydrothermal Bathing	1
Chapter Two: Hydrothermal Wellness Benefits	15
Chapter Three: Project Planning:Architecture & Design	31
Chapter Four: Thermal Bathing Areas – Function and Design	47
Hot and Dry: Finnish Sauna/ Russian Banya/ Bio Sauna/ Infrared Sauna	49
Hot and Humid: Steam Room/Caldarium/Sudatorium	55
Warm and Humid: Turkish Hamam/Moroccan Hammam	61
Warm and Dry: Laconium; Tepidarium/Warm Relaxation Room	66
Warm/Cold and Wet: Experience Showers; Foot Bath/Kneipp Walk	71
Cold: Plunge Pool/Frigidarium; Snow Room; Snow Shower/Snowfall	75

Chapter Five: Specialist Hydrothermal Treatments & Therapies	83
Specialist Rooms	87
Specialist Water Treatments	90
Specialist Beds/Tables	93
Chapter Six: Pool Areas - Function and Design	97
Lap/Exercise Pool	99
Hydrotherapy/Vitality Pool	100
Onsen Pool	102
Cold Plunge Pool	104
Specialty Pools: Floatation Pools; Watsu Pool; Mineral Pool; Kneipp Walk	105
Chapter Seven: Hot Springs & Geothermal Mineral Waters	121
Chapter Eight: Construction Materials and Building Services	137
Chapter Nine: Health, Safety and Hygiene	159
Chapter Ten: Sustainability and Regenerative Design	167
Glossary	175
Index	179
Photo Credits	182

Notice to Readers

Key terminology will be explained in the text. A glossary at the back of the book goes into further detail to help minimize confusion regarding the terms associated with modern hydrothermal spa areas.

There will be references to building codes and other safety guidelines the global hydrotherapy industry follows, but these references are not exhaustive and you will need to consult your relevant local codes and guidelines.

Foreword



By Susie Ellis
Chairman and CEO
Global Wellness
Institute

I have been in the spa and wellness industry for decades, and have been lucky enough to visit thousands of spas and sample hydrothermal experiences in every corner of the world...smoky saunas in the forests of Finland, historic hamams in Turkey, hot Russian banyas, sweet-smelling mud baths in Italy, sizzling Ayurvedic steam cabins in India and fun Arctic ice rooms in Las Vegas—to name a few. And I’ve loved each and every experience and have benefited from them both physically and mentally.

With extraordinary growth in the global spa/wellness industry—fueled by a rise in stress levels—these diverse experiences are becoming more important, and, fortunately, far more accessible.

However building hydrothermal facilities entails major challenges. And, if not built right, there can be serious consequences. The design, the “fit,” the installation and the maintenance of all these experiences—from a steam room to a cold plunge pool—are unique and tricky. I’ve seen many “fails” firsthand: whirlpools where the jets hit me in all the wrong places; a burnt hand from door handles made out of materials clearly not designed for a hot, wet environment; steam room ceilings that drip, drip, drip as I try to relax. And, of course, there are the saunas or steam rooms that were too hot, too cold, smelly or moldy. I have faced dreaded “out of order” signs too many times to count.

Yet when done right, hydrothermal experiences can become the highlight of a spa’s offering, with unrivaled wellness benefits that are difficult to achieve in any other way. And, the bonus is that all the health benefits are self-administered so they can be achieved without high labor costs, making a dedicated hydrothermal area a great revenue booster.

In order to build these diverse facilities correctly, precise technical knowledge is required: from material choice to complex drainage or electrical issues—this goes far beyond knowing which tiles withstand high temperatures or what wood holds up best in a sauna. Too often wet area specialists are consulted too late in a project – and unnecessary costs are incurred.

That’s why I’m so thrilled that you’re holding the *Guide to Hydrothermal Spa & Wellness Development Standards* in your hands. It’s designed to provide a 360-degree overview of what you need to know: from concepts and definitions; to how to assemble a project team; to design requirements for different types of hydrothermal experiences; to guidance on the correct building materials.

This guide is not written as a step-by-step manual for building hydrothermal experiences. Nor is it designed to cover all the standards and practices one must be familiar with—there are too many specific regional/national regulations to make that possible. Properties will always need to use wet area specialists/suppliers, but it is the first—and only—guide to provide a universal bird’s eye view of what all players need to know before they embark on one of these builds.

Because hydrothermal technology evolves rapidly, this book has been updated regularly (every two years since its introduction in 2014), and is constantly improved, with new ideas and best practices incorporated. You are currently reading the 3rd edition, published by the Global Wellness Institute’s Hydrothermal Initiative, whose focus is to increase transparency and awareness in the design and implementation of all elements of spa and wellness facilities involving thermal and wet treatments. Many thanks go to the Initiative’s members and the sponsors of this important resource!

Sincerely,

Susie Ellis

Chairman and CEO

Global Wellness Institute

Updated September 2018 for 3rd edition

Introduction

As the popularity of spa and wellness continues to grow—there are over 100,000 spas worldwide—more people are seeking authentic ways to positively impact their long-term wellbeing. Hydrothermal bathing, with its benefits of improving the immune system, managing high blood pressure and body detoxification and the potential for so much more, is one of the most ancient and proven spa treatments available. This is driving a significant increase in installations both in residential and commercial builds.

The main objective of the *Guide to Hydrothermal Spa & Wellness Development Standards* is to provide the spa, architectural and interior design communities with distinct, modern guidelines for the design and build of hydrothermal areas in public spas and private residences.

The goal is to provide readers—whether they be spa owners, consultants, developers, interior designers, architects, builders, professors, students or anyone embarking on the study or build of a hydrothermal facility—with a consistent and effective means to approach the planning and construction of these unique areas. More importantly, this guidance is also intended to help readers avoid costly mistakes.

In general, there are numerous design considerations, rules and codes to follow. In addition, there are specific building materials and technologies to consider. This handbook looks at all these areas, plus, common pitfalls and repeated mistakes that occur in the planning and building of hydrothermal bathing areas. And, of course, offers tips, tools and solutions for avoiding them.

The *Guide to Hydrothermal Spa & Wellness Development Standards* has the benefit of incorporating the accumulated experience of the leading practitioners in the modern spa industry. Spas around the world reflect the “good, the bad and the ugly” of hydrothermal design and implementations; by reading this book and using it as a reference, you are helping to make sure new builds include only the very best of hydrothermal spa standards.

This handbook is not designed as an exhaustive guide to a “model” hydrothermal build from beginning to end—you will need to employ specialist suppliers and/or consultants for this. It is, instead, a first step to familiarizing yourself with the key areas, understanding their functions and benefits and getting an overview that can guide you in your decision-making.

Industry Praise

“In the 40 years I have been designing spa and wellness destinations, one of the areas most prone to on-going maintenance problems and too-high capital costs, are the heat experiences and thermal areas. This book has been put together by those in the industry who understand these complexities and who have credibility and track record. It gives reassurance to developers, architects and designers who are not familiar with the technical expertise needed to deliver experiences which are now expected by well traveled consumers.”

Sue Harmsworth MBE, Founder of ESPA International

“The beauty of this guide is that it addresses all aspects of these builds: including financial/business issues; design, development and construction; health and wellness benefits and even recommended guest usage for each experience. If a commitment to a hydrothermal area is made, it’s imperative that experts are involved from the beginning of the project to ensure best results. WTS is thrilled to have this resource - it’s a treasure trove of information and our whole team refers to it often.”

Kim Matheson Shedrick, Senior Vice President, WTS International

“This is a much-needed resource produced by hydrothermal veterans who really understand the challenges in building innovative hydro and thermal features. The wisdom in this book is hard-earned and we encourage anyone looking to build a hydrothermal area to utilize it to its fullest!”

Cary Collier and Doug Chambers, Principals of Blu Spas, Inc.

“The financial success of any hydrothermal project depends on its careful planning and preparation—and this is exactly what this guide helps readers achieve. The insight into the overall design, construction and use of these spaces is unparalleled.”

Lynn Curry, President & Co-Owner, Resources For Leisure Assets USA



Contributors & Hydrothermal Experts

The Global Wellness Institute would like to thank the following companies for their contributions and support in making this guide come to life.





Overview of Hydrothermal Bathing

In this book, we explore the world of hydrothermal spa bathing, also known as “aquathermal spa,” depending on the use of either the Greek or Latin root of “water.” Put simply, these are areas where people get either wet (hydro) and/or experience a change of temperature (thermal).

For thousands of years, different cultures have sought to harness the cleansing and healing power of water and heat—both considered luxuries in ancient times. Access to either was often difficult. This prompted more civilized societies throughout the world to find creative ways to deliver “hydro” and “thermal” to their citizens.

Often the easiest way to do this was through natural hot springs, areas that have always played a key role in hydrothermal bathing. The abundance of hot springs around the globe made it possible for many cultures to take advantage of these sites to construct dedicated buildings on or around them, prompting the concept of public bathing.

The geo-thermally warmed waters that bubbled up from the earth’s core not only served to cleanse its users, but “taking the waters” was also believed (and is now medically proven) to deliver minerals to improve certain skin conditions and relieve pain from arthritis and other musculoskeletal ailments. As far back as

Hydrothermal bathing
has been practiced
for thousands of years.
The pools at Bath
Spa, UK.



Credit: Faena Hotel, Miami Beach (Nik Koenig)

The inhabitants of Northern Europe invented the sauna. Sauna at the Faena Hotel, Miami Beach.

the 7th century B.C., there are mentions of a “spring which contains sulfur to treat disease” in Chinese history books.

Private bathing areas were virtually unheard of in ancient times, so the most efficient means for washing was to gather in these public bathing spaces. Perhaps the best known and most cited examples of public bathing houses come from the Romans—their advanced technology and grandiose architecture (not to mention their geographical domination of Europe and Asia) positioned them as forerunners in hydrothermal bathing. But there are plenty of other cultures that also take credit for the invention of some of today’s popular hydrothermal applications.

For example, a highly popular and long enduring hydrothermal treatment is the Finnish sauna. With heat being such a prized resource in freezing Finland, the Finns devised a means to heat a wooden cabin to the highest degrees, causing the occupants to become very hot. Leaving the cabin, sweating profusely, they then used the snow outside to wipe off the sweat and dirt skin—and repeated the process as several times as the need to be clean dictated. This is why, even today, the Finns typically take a “roll in snow” after bathing in the sauna. The practical reason for diving into the snow is because running water was in short supply during the frozen winters of the north. But the result is

a cleansing/detoxifying ritual that is valued to this day and has been proven to improve the immune system and reduce blood pressure.

It should be noted that though Finland is often recognized as the birthplace of the sauna, the whole of the frozen northern Europe was known to have invented similar forms of bathing—for example, the Russian banya is almost identical in design and purpose.

In Eastern Europe, the Jewish people have had a tradition of sweating for their health that goes back more than 2,000 years. There are even frequent mentions of bath houses in the Talmud, the religious authority for traditional Judaism. Known as taking the ‘shvitz,’ the practice was originally adopted by Russian Jews in Russian banyas and was popular with Jewish immigrants in America during the 1920s. Also popular with orthodox Jewish men and women is the ‘mikvah,’ which literally translates as ‘a gathering or collection of water’. This water served as to ceremonially clean people prior to entering the temple and ultimately became a basis for the ritual immersion of baptism.

Today, mikvahs are not only built in a communal setting, but also constructed in private homes. There are some specifics for constructing mikvahs—they must be below ground and cannot be portable. A mikvah must have contact with natural water, so

Turkish hamams feature a heated belly stone (gobek tasi) as their centerpiece. This is where the traditional soap massage takes place.



mikvahs constructed in modern homes will normally have one primary pool filled with tap water and used for immersion, and a secondary pool where rain water or water from some other natural source is collected. A hole between the two pools will allow the water to mix, thus rendering the primary pool fit for ceremonial cleansing. Each Jewish sect has different practices regarding the use a mikvah, but the theme of spiritual purification and cleansing is common to all of them.

On the American continent, there is early evidence of “sweating” as a form of cleansing, including the use of aromatic herbs and flowers (or “aromatherapy,” as it’s known today). The Aztec tribes were particularly influential in their creation of two-story wattle-and-daub sweat rooms. In Mexico, the temazcal or “sweat lodge” is another example of thermal bathing; today, you can visit an excellent example of a Mayan steam room at the Chechen Itza site in the Mexican Yucatan Peninsula.

During the 16th century, the Ottoman Empire gave rise to the now-famous hamam (or Turkish bath). There is evidence, however, to show this form of bathing predates the Ottomans and was used widely in North Africa and the Middle East even prior to the rise of Islam. Once again using sweating as a form of cleansing, the traditional hamam became particularly popular before a visit to the mosque. The old hamams

of Istanbul boast beautiful interiors including fantastic examples of traditional Muslim ceramic and mosaic art with inscriptions from the Koran often being present on the walls. You can also find fine examples of hamams in Syria, Lebanon, Jordan, Tunisia, Libya, Algeria and Morocco. *Note: The Turkish hamam has a single central “m,” while the Moroccan hammam is spelled with two.*

Japan is also known for its extensive bathing culture with an ethic of cleanliness rooted deep in its culture. As long ago as the 3rd century, references to the Japanese habits of cleanliness surface in writings, and, in the 6th and 7th centuries, the rise of Confucianism and Buddhism further solidified the virtues of cleanliness in general along with the love of the ritual of bathing. Japan’s more than 20,000 natural hot springs formed the original onsens. The Japanese also developed a form of steam bath called the sento, a type of vapor bath that used aromatherapy elements and included body scrubbing. And, finally, the furo is a bath made of wood long enough for the bather to lie flat; it’s often found in private homes.

Another type of thermal bathing—mud bathing—originated in the Middle East thousands of years ago. This form of bathing wasn’t necessarily devised to “cleanse the masses,” but, instead, was a medicinal and beautifying ritual using the mineral-rich silt of the Dead Sea to treat skin conditions. Similarly, the

Ancient Egyptians valued the healing powers of the mud of the Nile delta, which delivered minerals and deposits from the high mountain ranges of Ethiopia.

And then in the 1900s, the French began harnessing the restorative properties of the sea—which is rich not only in sodium chloride (salt) but also minerals and trace elements. Known as “thalassotherapy,” treatments evolved to use warm seawater to allow the minerals to pass through the skin, complemented by algae, seaweed and alluvial mud applications.

Benefits of Hydrothermal Experiences

So the origin of hamams, saunas, onsens, etc., ultimately derived from the need to cleanse the body. However, there are now recognized health and aesthetic benefits associated with all forms of hydrothermal bathing. In recent years, medical science has explored the effects the immersion in hot temperatures, and the subsequent transfer to cold, has on the body—and have determined that a key benefit of such temperature change is detoxification. Getting hot and sweating out impurities is important to our health, and experiencing extreme changes in body temperature also increases the

circulation and gives the body functions a positive jolt.

The importance of thermal bathing, and the pleasure derived from it, is undisputed and well-recorded over the centuries, but it has only really been in the last 200 years or so that the medical profession has looked into the physical benefits, rather than just the ability to cleanse. In particular, there are multiple medical studies that confirm the reduction of hypertension with use of saunas. Evidence-based studies can be found at www.wellnessevidence.com, a portal designed to help people explore thousands of studies that have been done on common wellness therapies.

Although not scientifically proven at the time, the effect of the heat, and the minerals, along with the social aspect of communal bathing and the hygiene benefits that resulted, combined to create almost miraculous results. Even fertility was seemingly improved—in the 1700s, Queen Mary “took the waters” at the thermal springs in Bath, England while apparently suffering from infertility and 10 months later gave birth to a son.

In addition to the medical benefits, there is the simple notion of “thermal pleasure”—the feeling a person experiences when moving from a place

Japan is known for its extensive bathing culture; an onsen at Hoshino Resorts Co., Ltd. in Hakone, Japan.





Courtesy: Design For Leisure Ltd.

Roman Baths, Caesar's
Palace, Las Vegas,
Nevada, U.S.

where the temperatures have eventually made them uncomfortable to one where the contrasting temperature brings immediate relief and an almost euphoric feeling of pleasure. Hydrothermal spa areas provide this pleasure while delivering a social and ritualistic experience.

In the modern world, public bathing has evolved from being a necessity (i.e., the only way to cleanse the masses) to a ritual (and often a private one) that not only helps purify the body, but also one that gives us a chance to take a break from our busy, stressful lifestyles—allowing for complete and utter relaxation.

Modernization of Hydrothermal Spa Bathing

What is a “spa” anyway? Many think the term originates from the Latin “sanus per aquam,” which translates into “health through water,” while many Europeans associate the word with old European spa towns where natural springs, hot or cold, saline or sulfuric, produce endless quantities of natural water. Britons of the Victorian era were famous for traveling widely to “take the waters” of spa towns throughout Europe, which were believed to have medicinal or healing powers. Another suggestion is that the term “spa” comes specifically from another famous bathing site of the same name: “Spa” in Belgium.

Many of the now-famous European spa towns were actually put on the map over two thousand years ago during the Roman invasion of Europe, when the Romans brought their already advanced bathing culture to the lands they conquered. For example, Emperor Caracalla believed the hot springs of Baden-Baden in Germany cured his arthritis, and he consequently built one of the finest bathing houses outside Rome in this location.

It has often been said that a visit to a spa should be a journey of discovery—not just of new experiences, but a discovery of the joy of true relaxation and of self-indulgence. Spa and hotel developers, as well as homeowners, are realizing more and more that this journey can be significantly enhanced with the addition of hydrothermal experiences.

The ability to rest in the intense warmth of the sauna, to enjoy the benefits of steam bathing or salt inhalation, to exhilarate in a cold plunge, to refresh in the more gentle, cooling atmosphere of a snow cavern, and to invigorate with dips in specially designed hydrotherapy pools without the worry of time, is perhaps the ultimate in relaxation.

And, if between these experiences you can relax in comfort, either in silent relaxation spaces or, more socially, on heated loungers that may surround a hydrotherapy pool, the experience is enhanced.

Overview of Popular Hydrothermal Experiences

This section provides a brief overview of the areas seen most frequently in both commercial and residential builds, from the hottest to the coolest space.



Sauna

Generally a simple timber cabin with a heat source radiating warmth from the wood-clad walls via heated stones, warmed by electricity or gas, but traditionally by log fires, and normally operating between 70° C and 105° C. Many versions are available, but the most authentic are Kelo log-house saunas, which replicate the early origins of this form of bathing. However, as these are traditionally designed as independent external structures, the sauna has undergone substantial modernization as it has been brought inside spa buildings to form part of a hydrothermal bathing suite.

[Learn more on page 49.](#)



Infrared Sauna

Infrared saunas have grown in popularity in recent years due to their particular health benefits and because they are able to heat a bather's body without warming the air around it. Infrared radiation is on the longer range of the electromagnetic spectrum – and, because of this, is considered more gentle and comfortable and can penetrate the body's tissues more deeply.

[Learn more on page 54.](#)



Russian Banya

The term Russian banya literally means Russian bathhouse, but the term has been adopted to refer to the sauna-like room found in a Russian bathhouse. It's almost identical to a Finnish sauna in design and purpose, however it can have higher rates of humidity and bathers are encouraged to hit themselves or another person with “veniks” or bunches of dried branches and leaves from white birch, oak or eucalyptus trees to help improve circulation. In addition, there is usually an antechamber next to the banya for socializing, playing games and enjoying refreshments.

[Learn more on page 49.](#)



Steam Bath or Steam Room

Often called a caldarium or sudatorium from its Roman bath equivalent, a steam bath (or steam room) is typically a tiled or stone room reaching temperatures of between 42° C and 48° C with 100% humidity provided by hot steam, which is either created from heated waters in the room itself or, more commonly, pumped into the room using a steam generator. Aromatic extracts of essential oils can be injected concurrently to give the steam bath an added sensory element.

[Learn more on page 55.](#)



Hamam or Hammam

Also known as “Turkish baths,” or Moroccan hammams, modern hamams are normally larger than a steam bath. Turkish hamams have a traditional heated “göbek tasi,” or, literally, “belly stone,” as their centerpiece. A smaller replica located in an adjacent room will enable bathers to receive the soap massage in private. The heated floor, walls and benches warm the room to 40° C to 42° C with, possibly (but not essentially), 40% to 60% humidity from an independent steam source. An authentic atmosphere is achieved when the room is finished in traditional Turkish “Iznik” tiles and Carrara Blanco marble, although dramatic effects have been created in modern hamams using very different finishes.

[Learn more on page 61.](#)



Laconium

Again a name from the Roman era, this is a warm ceramic room, with a temperature of 38° C to 42° C, in which bathers can relax for long periods of time in comfortable ergonomically designed benches or individual, heated loungers or chairs. The walls, floors and benches are heated to enable deep penetration of the warmth to the body, promoting a feeling of wellbeing and relaxation. Aromas can be introduced via a humidifier to enhance this beneficial treatment and maintain a comfortable atmosphere. Heated loungers are often provided in ceramic or stone (or other impervious finishes) to the quiet spaces around the wet areas of the spa, as they are particularly suitable for relaxation between thermal treatments/baths.

[Learn more on page 66.](#)



Tepidarium or Relaxation Spaces

Once again taking origins from the ancient bathing cultures, these areas were known as tepidariums by the Romans; sometimes smaller, more intimate spaces were provided for rest—and even sleeping—and were known as refugiums. Fitted with a range of different beds and loungers, these spaces are essential to any spa. When allocating space to a relaxation area, consideration should be given to the fact that after bathing in a sauna for 10 minutes, it will take at least 20 minutes for the bather's body temperature to equalize, which is the only time he/she should return to a warm/hot cabin or pool. Logically, there should at least be as many seats/loungers as there are total places in the thermal cabins and pools.

[Learn more on page 69.](#)



Salt Room

Salt rooms have steadily grown in popularity—however, it should be noted that though a “salt wall” is aesthetically pleasing and salt on the floor has a welcoming feel neither of these uses of salt provide any real benefits. The only way to truly benefit from salt is via inhalation—which is proven to cleanse respiratory passageways and promote long-lasting lung health. For a salt room to be effective, finely powdered salt must be introduced into the air via a halo generator or by nebulizing brine vapor into the space. Among other things, salt therapy relieves asthma, improves circulation and may lower blood pressure.

[Learn more on page 88.](#)



Mud Bath

Mud bathing originated thousands of years ago as a medicinal and beautifying ritual—depending on the minerals inherent in the mud, these baths can cleanse, exfoliate, absorb toxins, increase circulation and soften the skin. The bather can either be fully immersed in mud, or the mud can be applied by a therapist or a bathing partner.

[Learn more on page 89.](#)

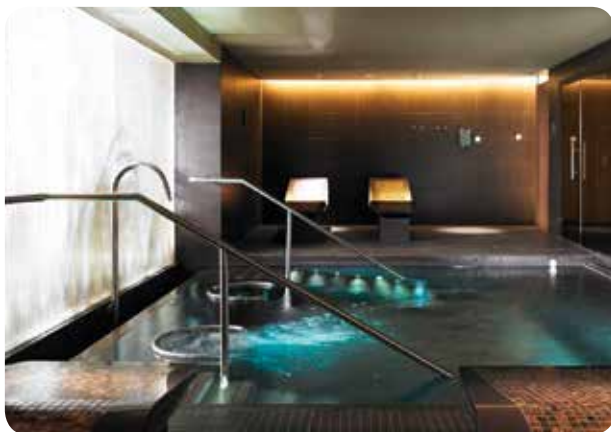

Vitality Pool

A vitality pool is the generic name for what people commonly refer to as a “Jacuzzi” (the brand name that has become synonymous with pools with water jets). Vitality pools offer a mini-hydrotherapy experience and are typically used where space will not permit the inclusion of a full-size hydrotherapy pool. These pools typically operate at 35° C to 38° C and will have underwater pressurized air and water features.

[Learn more on page 100.](#)



Kneipp Walk

Kneipp therapy was founded in the 19th century by Sebastian Kneipp, a Bavarian parish priest, who was ill with tuberculosis and developed this “water cure” to heal himself. Kneipp therapy does not always take place in a pool—in fact hot and cold compresses can be used—but, pools are most common. The Kneipp walk uses a mix of hot- and cold-water actions (stepping through the water) to stimulate the circulation of blood. Pebbles on the bottom of the stream/walkway massage the feet, and the alternation of hot and cold baths stimulate circulation of all parts of the body. There are two walks used—the bather begins by stepping in hot water and then moves to cold water.

[Learn more on page 107.](#)



Foot Spa

The foot spa is traditionally an area where warm ceramic or mosaic benches offer a place to relax and be comfortable, while bathing the feet in cool or warm (never hot) water. Feet are especially important in the heating and cooling process of a hydrothermal journey because the small amount of flesh and fat on them, combined with the large number of blood vessels, allow this cooling or warming effect to be conveyed through the body via the heated or cooled bloodstream.

[Learn more on page 74.](#)



Experience Shower

There are a huge variety of showers—cold waterfalls, mists, body jets and dramatic “experience showers”—offering multi-sensory experiences that incorporate smells, sound and visual effects that help take the bather to another world.

[Learn more on page 71.](#)



Deluge Shower

A deluge shower takes things a bit more back to basics by delivering a huge dump of cold water on bathers so they can adequately cool between heat treatments.

[Learn more on page 71.](#)



Hydrotherapy Tub

Individual hydrotherapy tubs deliver a unique sensation of heat, buoyancy and hydro-massage. Jets can be positioned to stimulate and relax trigger points in the body. High-quality units will massage body zones, beginning at the feet and going towards the upper part of the body, and will have automatic programs with different focuses and varying pressures. Aromatherapy oil can be added to the baths to intensify the bather's relaxation and engage the other senses. Soothing skin products are often used. The natural healing power of mineral water or seawater can increase their effectiveness.

[Learn more on page 91.](#)



Floatation Pool/Tank

A floatation pool or tank cocoons the entire body (an experience that is often likened to going back to the womb). The water in the tank is kept at body temperature and the most important ingredient is the magnesium sulfate (Epsom salt) that is dissolved in the tank to create a weightless "float." The buoyancy of a float tank's dense salt water solution supports the muscular, skeletal and circulatory systems with zero pressure, while the absence of external stimuli enable the mind and body to give itself over to complete rest, relaxation and recovery.

[Learn more on page 105.](#)



Watsu Pool

Pools designed specifically for Watsu massage, a gentle form of body therapy performed in warm water that combines elements of massage, joint mobilization, shiatsu, muscle stretching and dance. The bather is continuously supported while being floated, cradled, rocked and stretched.

[Learn more on page 106.](#)



Vichy Shower

A Vichy shower is a horizontal series of showerheads forming a “rain bar” over a waterproof, cushioned table that features drainage on the side for all the excess water. This is a therapist-controlled water massage designed to increase blood circulation, hydrate the skin and soothe/relax muscles.

[Learn more on page 90.](#)



Dry Floatation Bed

Dry floatation beds offer a sense of weightlessness and are used in combination with a body wrap and often include soft hydro-massage features. Because the unit can be stable, manual massages can also take place on the bed, making it a very flexible choice in a modern spa.

[Learn more on page 93.](#)



Dry Hydro Massage Bed

Dry hydro massage beds are an option for spa guests who crave the therapeutic, massaging benefits of water jets and pressure—without the actual water! Water nozzles placed below a rubberized cover are used for the application of a relaxing massage. Because there’s no contact with water, the customer can stay fully clothed and needs minimal assistant from a therapist, making this a very efficient piece of equipment.

[Learn more on page 95.](#)



Plunge Pool/Frigidarium

Traditional cold-water pools stem from the Romans who realized that the surge of blood, caused by contracting blood vessels, which had previously expanded in the hot rooms, was a particularly invigorating experience. Purists would have it that a plunge pool should be barely above freezing point, but temperatures of 12° C to 20° C are effective. These were dubbed Frigidariums by the Romans.

[Learn more on page 76 and 104.](#)



Snow Room

There can be nothing more exhilarating than stepping from a traditional sauna into a landscape covered with a fresh fall of real snow with which to cool the body. Operating at -10° C to 0° C, these rooms are becoming features in some modern spas, as we slowly, but surely, retrace our steps to provide ever more authentic experiences closer to the origins of the treatments we all now desire.

[Learn more on page 77.](#)

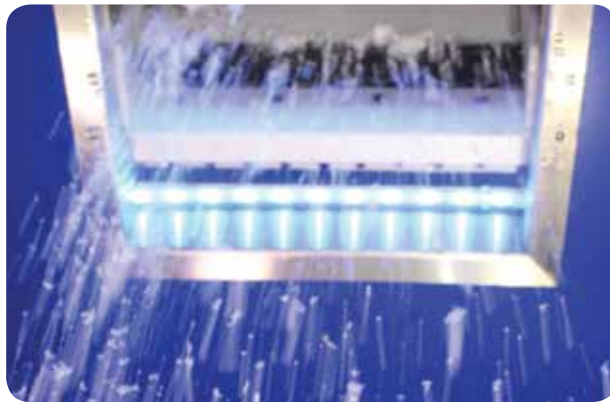

Snow Shower/Snowfall

Snow showers are either open or closed areas where a continuous snowfall can be generated by the push of a button. They are most commonly integrated into the hydrothermal cycle after a visit to a sauna or steam room as a gentle way to cool down after the hot cycle. Melting snow on the skin versus jumping into a cold plunge pool can be an easier way to cool-down for many bathers.

[Learn more on page 80.](#)



Ice Fountains

An ice fountain is often found inside a snow room. The powdery snow can be applied to selectively to cool the extremities of the body, such as legs and arms. The very cold snow reaches temperatures below 0° C and the process of rubbing the snow onto arms and legs assists cooling in those areas.

[Learn more on page 77.](#)



Hydrothermal Wellness Benefits

The benefits of heat and water can be enhanced with the addition of restorative-promoting minerals infused or naturally occurring in the waters or externally applied muds and creams; while aromatherapy, which incorporates all our senses, delivers further restorative and calming benefits.

For centuries, hydrothermal treatments have been recommended in the treatment of certain medical issues and ailments. Today, there is mounting medical evidence that supports the use of hydrothermal therapies for treating a wide range of medical conditions—including common ailments like arthritis, sports injuries, chronic pain, and cardiac disease. This chapter offers a primer on the wellness benefits behind many of today’s hydrothermal treatments—whether hot, cold, wet or muddy—and directs readers to additional resources for further research.

As noted throughout this guide, the healing powers of water and heat have been harnessed throughout the ages to provide physical solace, comfort, healing and, of course, simply bathing. Even as far back as 339 BC, history notes that some Roman baths were specifically used for healing purposes and people visited them to help with rheumatic diseases, paralysis and injury recovery. And, of course, the people of the

Nordic countries have a long tradition of hot and cold contrast therapy—using the hot, dry heat of saunas in combination with a freezing “roll in the snow”—has been shown to promote heart health, detoxification and even reduce blood pressure.

Medical Evidence for Hydrotherapy

Hydrotherapy, using water and heat together to treat conditions, relieve pain and increase muscular power and a range of joint movement, has been a mainstay of managing many medical conditions. These include arthritis, neurological conditions and rehabilitation from sports injuries. Mark Liponis, M.D., Chief Medical Officer at Canyon Ranch (Lenox, MA, USA), observes that the wide-ranging health and well-being benefits of hydrotherapy include: general relaxation; counteraction of gravity and a creation of buoyancy; fluid dynamics for bodywork/massage/rehabilitation; water’s unique molecular and electric healing properties; water’s ability to deliver healing additives, such as magnesium salts, sulfur compounds, radiation (radon); and “floatation” or sensory deprivation tanks for mental health/relief of anxiety/depression, etc.

Dr. David Marshall, a specialist physician in rheumatology and professor at University of Glasgow, has reviewed and catalogued more than 300 research papers and articles identifying the benefits of hydrotherapy on these conditions:

1. Arthritis
2. Chronic pain conditions
3. Diseases of the nervous system
4. Cardiac disease
5. Respiratory disease
6. Miscellaneous, including obstetric care, immunology, dermatology and sports medicine

(Readers are encouraged to download the full paper at www.globalwellnessinstitute.org/hydrothermal-resources-page.)

Hydrothermal and Physical Therapy

According to the aforementioned white paper, the physical benefits of using water in therapeutic exercises can be attributed to four main properties: heat transfer, Archimedes forces, hydrostatic pressure and sensory input.

In addition to reducing pain, hydrotherapy can be used to specifically improve:

- Strength and/or prevent muscle wastage
- Posture, flexibility and/or prevention of contracture (shortening and hardening of muscles, tendons or other tissue)
- Ability to perform normal everyday activities, including walking
- Exercise and work tolerance
- Cardiovascular fitness
- Balance and reaction times

Heat Transfer

When a body is immersed in water at a temperature greater than 35° C (36° C to 40° C), heat transfer occurs from the water to the body. This leads to cutaneous vasodilation with heating of the blood circulating under the skin. Arterial blood pressure drops due to this vasodilation. Evaporation of the sweat produced as a result of this increase in temperature is impossible below the surface of the water. The core temperature therefore rises. Immersion at temperatures below 40° C leads to stimulation of warm receptors. This leads to inhibition of the activity of motor neurons, which leads to muscle relaxation. An increase in the superficial tissue temperature creates a palliative effect and pain reduction may be experienced. If the immersed individual exercises, body temperature will increase even further.

Archimedes Forces

Archimedes’ principle states that when a body is wholly or partially immersed in a fluid, it experiences an upthrust equal to the weight of the fluid displaced.

Buoyancy-assisted hydrotherapy sessions provide relief of painful weight bearing joints.



This upthrust is what we call “buoyancy,” and is the force that counteracts gravity, supporting the body in water. The more of the body that is immersed, the more buoyancy there is and weight bearing is further reduced. The reduction in weight bearing leads to relief from compressive forces on painful weight bearing joints.

Therefore, someone who generally suffers pain in their back or legs when standing or walking will find those activities much less painful under water. Indeed, such individuals may well be able to exercise to aerobic levels in water. Buoyancy can also promote an increase in movement where there is muscle weakness and be used to develop a graded program of exercises, the easiest of which would be buoyancy-assisted, moving to buoyancy-eliminated (harder) and progressing to buoyancy-resisted (hardest).

Hydrostatic Pressure

Pascal’s Law states that fluid pressure is exerted equally on all surfaces of an immersed body at a given depth. Pressure increases as depth increases. This principle

can be used therapeutically to help reduce edema and lower limb swelling (by exercising at greater depths). Hydrostatic pressure can restrict chest wall expansion, a factor important in those with reduced pulmonary function this should be taken into account. Hydrostatic pressure may be used in a progressive resistive exercise program in such individuals.

Sensory Input

In water there may be less fear of falling as the water provides support and stability. It is much less traumatic to fall into a compliant medium (water) than on a noncompliant one (ground). A less anxious person may be happier to challenge their body and, therefore, develop their balance and movement skills.

An immersed body will move more slowly as the viscous medium retards movement and sensory awareness may be increased by moving through a more viscous medium (water) compared to a less viscous medium (air). If a person moves quickly through water they produce drag or turbulence. This is another resistive force and can again be used therapeutically, for further muscle strengthening.



Courtesy: Klafs GmbH & Co.

Health Benefits of Sauna

By Dr. Mark Timmerman

Dr. Mark Timmerman is a Family Physician and Sports Medicine Specialist in Wisconsin, USA. He has a wood heated sauna in his home and takes a sauna at least three times each week.

The use of heat while bathing has been an integral part of many cultures for centuries. Finland is well known as a society of avid users of the sauna, which usually produces a relatively dry heat between 70° C to 100° C. The traditional Finnish sauna is a smoke sauna (“savusauna”) where stones are heated with a fire for several hours and then the sauna is taken after much of the smoke has cleared from the sauna building. More commonly today, saunas are heated by stoves using wood, gas or electricity, and water is used intermittently on the stones to produce steam.

Other cultures known for their heat bathing traditions include Russia (Banya), Lithuania (Pirtis), Sweden (Bastu), and Turkey (Hammam). Here in the United States, the American Indians traditionally have used sweat lodges for spiritual ceremony. The rest of American sauna culture has been influenced by European immigration during the late 1800’s and early 1900’s. In my own case, for instance, I grew up in a northern Minnesotan town where many Finns immigrated in order to work in iron ore mines. Many of us therefore had saunas in our basements or at our lake cabins.

Sauna bathing usually involves several repetitions of alternating heat with cold, such as 15-20 minute heat exposures interrupted by dipping in a pond, taking a cool shower, or sitting outside. In some cultures, oak or birch twigs and leaves and/or steam are used to provide a more intense heating and massaging experience.

Health Benefits

There are many myths regarding the physiological and psychological affects of sauna bathing. Unfortunately, we lack sufficient large, controlled studies in the medical literature to help fully understand the science supporting these myths. We have learned a significant amount about the physiologic adaptations of the body to heat bathing, however, and there is a growing body of scientific study, especially from Germany and Finland, to help understand the real benefits and risks of the practice.

Physiologic Response

Essentially, the effects of heat bathing are the body's way to deal with heat stress. In other words, heat exposure causes a person's physiology to react to that form of stress out of self-defense in order to prevent injury. The systemic adaptations that occur over time can indeed make a person stronger, similar to adaptations to regular exercise.

Initially, as the body is exposed to the heat of a sauna, the skin temperature increases. As a way to dissipate the heat and protect the internal organs, the body decreases blood flow to those organs and increases circulation to the skin. In addition, sweat glands are stimulated in order to allow for evaporation and further cooling effect.

Because the blood volume to the periphery and skin is increased, the heart rate must also increase so that the internal blood pressure can be maintained. While the overall work of the heart does not change significantly, the pulse can increase up to double the normal rate.

Breathing becomes more rapid and shallow in the sauna, and the overall flow rate and lung capacity increases, suggesting more efficient pulmonary ventilation and allowing for additional heat dissipation.

The sympathetic nervous system is also stimulated as skin temperature rises, causing a "flight or fight" response. Stimulation of the hypothalamus and pituitary glands in the brain, which communicate with the adrenal glands near the kidneys, causes release of cortisol ("adrenaline"), creating a heightened sense of alertness, reduced perception of pain, and elevated mood. Interestingly, when a sauna is followed by a plunge into cold water, this adrenaline response is elevated even more.

Cardiovascular Benefits

There is good scientific data to support the beneficial effects of repeated sauna exposure for the heart. In particular, a person's resting systolic blood pressure can decrease as much as 10 points after just three 20 minute sauna sessions several days apart. Some studies have found up to a 20-point systolic blood pressure

decrease with regular sauna exposure (such as twice per week) over a several month period.

Congestive heart failure, which is related to poor pump function of the heart, has also been shown to benefit from regular sauna exposure. Both symptoms and heart rhythm abnormalities improve predictably with regular sauna use.

Importantly, because the workload on the heart is generally not increased in the sauna, the risk of myocardial infarction ("heart attack") in the general population is not higher during sauna bathing. While it is usually recommended that a person who has had a cardiac event or procedure should wait at least 6 weeks before going back to sauna bathing, it is considered to be safe practice for people with heart disease.

Training Effect

Because many of the body's adaptations to sauna are similar to its response to exercise, many people wonder if taking a sauna can improve cardiovascular fitness. While one recent study has suggested that endurance performance does improve for runners who recover in the sauna after training, in general one's fitness does not improve with routine sauna bathing alone.

With regular sauna bathing, however, the body does adapt to heat stress, so that one can tolerate longer and hotter sauna exposures without injury. People who are new to saunas are therefore encouraged to moderate their heat exposure by limiting their time in the sauna, or by sitting on a lower bench. In addition, athletes who use the sauna routinely are able to exercise more efficiently and perform better in warm temperatures.

Respiratory Benefits

Part of the sympathetic nervous system response also relaxes smooth muscle in the bronchioles of the lungs, allowing for more efficient respiratory function. Patients with both asthma and chronic obstructive pulmonary disease generally report improved symptoms and ease of breathing while in the sauna, although longer-term studies have not generally shown an overall improvement in lung function with regular sauna use.

Musculoskeletal Benefits

During a sauna, joint synovial fluid becomes less viscous, allowing for improved joint mobility, and skeletal muscle is relaxed. These changes, along with the increased pain tolerance that one experiences, provide for a significant subjective decrease in musculoskeletal pain. Interestingly, for patients with rheumatoid arthritis and other autoimmune disorders, pain and inflammation have found to be increased on the day after taking a sauna—unless the sauna bath is followed by a cold immersion. For patients with arthritis that use cold-water bathing after sauna, there can be an overall improvement in symptoms.

Immune System

There are some studies that support the notion that regular sauna use stimulates the immune system. During a sauna session, white blood cells increase in the bloodstream, suggesting an elevation of the body's natural defense against illness. With routine sauna practice, at least one study has shown a decrease in the incidence of the common cold.

Psychological Benefits

One of the most common reactions to taking a sauna is that it simply seems to make people feel better. As it turns out, there are some measurable scientific reasons behind that.

Sauna exposure causes a significant release of Dopamine, a neurotransmitter, and Beta-Endorphin, a neuropeptide hormone. These substances cause a sense of euphoria, as well as improved mood, energy, sense of calm, and pain tolerance. (Endorphin is a combination of the words “ENDOgenous”, or occurring naturally in the body, and “moRPHINE”, a pain-relieving compound). The level of endorphins released during sauna bathing can be three times normal, similar to a middle distance training run. This “runners’ high” that occurs can be somewhat addictive and may affect regular sauna users in the same way it affects regular exercisers.

Sleep is also improved after a sauna, with some research

showing longer stage 4 sleep, which provides a deeper, more restful sleep and healthier dream activity. Sleep affects so many other aspects of health, including mood, immune function, and ability to handle stress, that this alone would seem to suggest a significant health benefit from regular sauna use.

The psychosocial aspects of group activity such as sauna bathing may also be an important part of the health benefits of sauna. Social connection, sharing with friends and feeling a part of a community, as well as the personal nature of conversation that is fostered in the sauna, all play parts in the cultural validity of group sweating that has existed in so many cultures over time. In addition, for those cultures that promote nudity in the sauna, a sense of equality and openness exists that one does not normally experience in every day life.

Risks

While quite safe if done in moderation, sauna bathing can present health risks. Because the body uses sweat to help regulate core temperature during a sauna, dehydration can be a problem with excessive sauna use. Some athletes, such as wrestlers, have used the sauna for rapid weight loss through loss of water through sweat, and this has occasionally led to heat stroke and sudden cardiac death. When combined with the misuse of diuretic pills, this practice can be especially dangerous.

Alcohol consumption creates many potential risks for the sauna user. Alcohol counteracts the anti-diuretic hormone that the body normally secretes during heat stress in order to help the kidneys retain fluid. In addition, alcohol causes the peripheral blood vessels to become even more dilated than usual in the sauna, which can lead to rapid fall in blood pressure and cause falls or fainting. Alcohol also excites cardiac muscle and reduces coronary artery flow, increasing the risk of both arrhythmia and myocardial infarction.

Cold-water immersion is a common practice following sessions in the sauna. This causes rapid constriction of the skin blood vessels, which causes blood pressure to

Often missing from wellness seekers' sauna therapy is the cold immersion required to intensify the healthful results—a snow room or plunge pool (natural or man made) are ideal adjuncts to a sauna.



Courtesy: TechnoAlpin S.p.A.

increase (as opposed to in the sauna where it remains stable). There is also a significant stimulation of the sympathetic nervous system, with rapid increase in adrenaline, heart rate, and also endorphins. Hence, the sense of euphoria and well being that one experiences following cold immersion intensifies that from taking a sauna alone.

Data is mixed regarding the benefit of cold immersion for muscular tissue following exercise, but there are several studies that support improved blood flow and more rapid recovery of muscular damage and soreness with cold immersion. As mentioned above, those with inflammatory conditions like rheumatoid arthritis demonstrate benefit with cold water immersion following sauna bathing.

Of concern, however, is the fact that cold immersion can lead to cardiac arrhythmia and coronary artery spasm, making it potentially dangerous to those with heart disease. There are cold receptors in the face and scalp that respond to a rapid fall in temperature. This stimulates the “diving reflex”, which is a complex cardio respiratory reaction that causes apnea and a sense of shortness of breath, decreased cardiac output, and rapid decrease in pulse. Heart arrhythmias are common during this response, and can pose a danger to those prone to dangerous heart rhythms or at risk for heart attack.

As we can see, while people with heart disease can generally use the sauna safely, this is a population that should absolutely avoid alcohol before and during sauna bathing. In addition, these individuals should take extra caution when plunging in cold water to avoid exposing the face and head. A cool shower or slower cooling simply by sitting outside is generally considered safer practice for this group.

In conclusion, sauna bathing causes the body undergo many physiologic changes in attempt to protect itself against heat stress. Some of those adaptations can provide health benefit, most notably to resting blood pressure. There also evidence to suggest improved function in other aspects of cardiac, respiratory, musculoskeletal, and immune function. Regular sauna use increases the ability for athletes to train or perform in heat, and post exercise saunas may improve endurance. Many of the benefits of sauna bathing are psychological, including improved sleep, mood, and pain tolerance. Cold plunging following a sauna can accentuate some of these benefits, but caution is advised regarding immersion of the face and head. Alcohol use before and during the sauna is also ill advised, as is the practice of using the sauna for rapid weight loss. Otherwise, sauna bathing is considered very safe and regular use can benefit overall physical and mental health.



Courtesy: Sommerhuber

Heat storage ceramics provide mild, pro-active infrared C radiation to irradiate the whole body.

Benefits of Infrared Heat

Infrared saunas have grown in popularity in recent years due to their particular health benefits and the ability to heat a bather's body without warming the air around it.

Infrared radiation is heat that is on the longer range of the electromagnetic spectrum—and, because of this, it's considered more mild and comfortable and is able to penetrate the body's tissues more deeply. The water molecules in our body are the first to react to infrared heat and, once activated, they dilate the blood vessels and set the entire metabolism in motion. Infrared heat has a unique ability to penetrate into the skin—the longer the wavelength, the more soothing and relaxing the experience is.

The longer wavelengths are absorbed by the upper layers of the skin (epidermis), where the autonomic nervous system is located. Our autonomic nervous system coordinates both voluntary and involuntary actions, transmitting signals to and from different parts of the body. Involuntary actions, like blood flow and the operation of internal organs, are controlled by the parasympathetic nervous system. Its tasks include regulating the body to its environment, like

maintaining core body temperature of 37° C by adapting its biological rhythms. The nerve endings in our skin respond to temperature stimuli and by irradiating the whole body, the nervous system is activated and metabolism is set in motion. Some of the benefits include:

- Increased metabolism
- Increased relaxation, reduced tension
- Replenished, rejuvenated skin
- Increased oxygen supply which, in turn, heats the body and burns fat
- Detoxification
- Stimulate blood flow
- Reduce blood pressure
- Decrease pain and inflammation

Heat storage ceramics (versus a separate infrared radiator) provides a mild, pro-active infrared experience that emits infrared C radiation (long-wave).

Contrast Therapy: The Dr. Thuile Method

Dr. Christian Thuile, Medical Director of the Department of Complementary Medicine at the Merano Hospital in South Tyrol, Italy and author of *Schneesauna – Die Wellness-Revolution (Snow Sauna – The Wellness Revolution)*, has developed a guide on how to most effectively use snow rooms in conjunction with saunas.

The method is based on a number of scientific studies that have assessed bodily reactions to the effects of the cold. The conclusion is that, when used correctly, the hot and cold contrast can lead to a number of health benefits, including reducing fatigue, improving rheumatoid arthritis, pain reduction as well as minimizing muscle soreness after activity and improved regeneration after intense training.

The Dr. Thuile Method is based on the alternating between a heat source, such as a sauna, and a snow room (-10° C to 0° C). By following the Dr. Thuile Method, blood vessels extend and contract quickly resulting in improved blood circulation in the entire

body. Furthermore, more oxygen and nutrients are transported to cells, strengthening them and benefiting the heart and circulatory system.

After spending time in a hot sauna, the body is fully warmed and muscles are more mobile and relaxed, cramps are loosened, connective tissues are more elastic and pores are opened. Many people experience exertion and fatigue after a sauna experience. Cooling the body down and bringing it back to its natural temperature as soon as possible is a necessary step.

The cold of a snow room is often perceived to be less invasive than a cold or wet option (frigidarium), allowing bathers to spend more time in the area, thereby maximizing the effects. When in the snow room, it is highly recommended that one use the powdery snow to additionally cool the extremities of the body, such as legs and arms. The very cold snow reaches temperatures below 0° C and the process of rubbing the snow onto arms and legs assists cooling in those areas. The positive side effect is that one can

Snow rooms can be a more appealing option to jumping into the freezing cold waters of a plunge pool.



Courtesy: TechnoAlpin S.p.A.

avoid the intensified cooling on other more sensitive areas of the body. The cold can be specifically applied to assist in reducing inflammation and joint soreness as well.

Immediately after entering a snow room, the body begins to react to the cold, causing vascular constriction or vasoconstriction—a narrowing of the blood vessels—and, in the cold ambiance, the blood flow centralizes to protect vital organs.

The contrasting vasodilation—expansion of the blood vessels—that occurs in the heat of sauna, followed by the vasoconstriction causes increased blood flow to the skin, muscles and tissue. According to Dr. Thuile, this can be particularly beneficial for people with low blood pressure, especially if repeated on a regular basis.

Of over 200 people studied using a snow room in combination with a Finnish sauna, subjects reported improved sleep, significant pain reduction, better moods and an increased amount of energy, relief from stress and pressure, improved breathing, softer skin and a healthier sense of self.

Benefits of Aromatherapy

Humans have been using aromatherapy (defined by the National Association for Holistic Aromatherapy as the therapeutic application or medicinal use of aromatic substances for holistic healing) to improve mood and well-being since time began. Very little specifics are known about the history of aromatherapy, but Egyptians are credited with developing the earliest distillation process for extracting oils from certain plants which they then used to embalm the dead. It's the Chinese who are believed to have begun the practice of using infused aromatic oils as mood enhancers or to help with physical aches and pains. The Greeks also played a role: Greek mythology claims that the gods were gifted with the knowledge of perfume and fragrance. However, the term “aromatherapy” was originally coined by the French chemist Rene-Maurice Gattefosse in 1937 after discovering the healing and soothing effects of lavender oil on burns he suffered in a lab accident; and a French surgeon, Jean Valnet,



Courtesy: Gharieni Group

The use of aromatherapy to improve mood and well-being is long documented in many cultures. Today, aromatherapy is an important part of any spa and wellness offering.

Each essential oil has its own unique attributes and are often used to relieve both mental and physical ailments.



adopted essential oils to help heal soldiers' wounds during World War II. Today, the intense effect fragrances have on our state of mind is well known and aromatherapy is common not only in spas around the globe but everywhere humans dwell.

Scents are so powerful because our olfactory receptors transmit nerve impulses about odors to the central nervous system. As the signals reach the brain, they affect our autonomic nervous system and can cause subtle changes in our bodies, including on our heart rate, blood pressure, breath, memory, stress, and even hormone balance. The olfactory pathway also connects to our limbic nervous system, which is responsible for processing emotions and instincts and includes the hippocampus, which is responsible for long-term memory—something that helps explain why the whiff of certain fragrances can bring up spontaneous images and memories deep in our subconscious.

Aromatherapy is very effective in hydrothermal areas and most commonly used as an inhalant—breathed in through the nose via steam or vapors—and, of course, essential oils can also be blended with carrier oils and/or lotions and applied topically.

Essential oils are attributed with mood enhancing properties and are commonly used to treat the following:

- **Agitation:** Chamomile (Roman), Lavender, Mandarin, Sandalwood
- **Anxiety/Fear:** Bergamot, Chamomile (Roman), Cedarwood, Frankincense, Jasmine, Lavender, Neroli, Patchouli, Rose, Sandalwood
- **Fatigue:** Basil, Bergamot, Clary Sage, Frankincense, Ginger, Grapefruit, Jasmine, Lemon, Patchouli, Peppermint, Rosemary, Sandalwood
- **Isolation:** Chamomile (Roman), Bergamot, Clary Sage, Frankincense, Rose
- **Memory Boosters:** Basil, Cypress, Lemon, Peppermint, Rosemary
- **Sadness/Grief:** Bergamot, Chamomile (Roman), Clary Sage, Frankincense, Grapefruit, Jasmine, Lavender, Lemon, Orange, Rose, Sandalwood, Ylang Ylang
- **Self Esteem:** Bergamot, Cypress, Grapefruit, Jasmine, Orange, Rosemary
- **Stress Relief:** Bergamot, Chamomile, Lavender, Lemon, Orange, Patchouli, Vanilla, Ylang Ylang

Common Essential Oil Attributes

Essential oils all have different uses and effects, below are the attributes of some of the more widely used scents:

Basil: Used to sharpen concentration and alleviate some symptoms of depression.

Bergamot: Used to treat stress, depression, anxiety, anorexia, and a number of skin infections like psoriasis and eczema. Can also stimulate the liver, digestive system and spleen.

Cedarwood: A calming agent that alleviates stress and anxiety. It also plays a role in aiding respiratory problems as well as skin issues.

Chamomile: A powerful calming agent, as well as antibiotic, antiseptic, antidepressant and overall mood lifter.

Eucalyptus: Commonly used to treat respiratory issues, and also as an antiseptic, antispasmodic, decongestant, diuretic and stimulant. Its cooling properties help with muscle aches and pains and can also be used to fight migraines and fevers.

Jasmine: This scent increases the beta waves in the brain that are linked to alertness, it's also thought to ease depression and to enhance libido.

Lavender: Commonly used for stress-relief and to enhance relaxation and sleep. It is also said to relieve headache and migraine symptoms.

Lemon: Can be used to help relieve the symptoms of stress and depression. It also helps with skin irritation, digestion and circulation problems.

Marjoram: Aids in relieving anxiety and stress, also used to combat fatigue and depression and alleviate respiratory and circulatory issues.

Patchouli: Said to promote skin cell growth, it also helps relieve anxiety, depression, fatigue, and reduce bloating.

Peppermint: Cooling agent that enhances mood, sharpens focus, combats irritation and redness, alleviates symptoms of congestion, and aids in digestion.

Rose: A multi-purpose scent that helps with depression, anxiety and digestion issues. It is also helps with circulation, heart problems and respiratory conditions like asthma.

Rosemary: Widely known as a stimulant, its antidepressant properties make it ideal for enhanced memory, focus and overall brain performance. It also acts as an analgesic, soothing aching, cramping muscles, headaches and migraines. As an antiseptic it helps with digestive and liver infections.

Sandalwood: Most often used for its calming and aphrodisiac properties.

Tea tree: A natural immune booster with antimicrobial, antiseptic, and disinfectant qualities that is commonly used in shampoos and skin care products to treat acne, burns, and bites.

Ylang-Ylang: Calming scent that soothes headaches, nausea, skin conditions, and is thought to reduce high blood pressure and fight intestinal problems.

Essential oils have numerous benefits, but if used improperly the effects can be hazardous. For example, photosensitive oils like bergamot, grapefruit, lemon, lemongrass, lime, and sweet orange can act as a sun enhancer or burn the skin so should be avoided in hydrothermal areas.

Benefits of Floatation Therapy

Unlike other hydrothermal modalities discussed throughout this guide—which can be traced back centuries to ancient civilizations—the practice of floatation therapy is part of modern history, dating back to the 1950s when Drs. Jay Shurley and John Lilly at the National Institute of Mental Health became interested in understanding how the human brain would respond to an environment devoid of external sensory input. Since then, there have been a number of publications that have explored the potential therapeutic benefits of floating. The most consistent observation to date has been significant reductions in levels of subjective stress and increases in relaxation as measured from pre- to post-float. In addition, floating has also been reported to decrease blood pressure, heart rate, and cortisol levels.

In recent years, there's been a marked increase in interest of Floatation-REST (Reduced Environmental

Stimulation Therapy) both for its benefits of alleviating chronic pain—the buoyancy of a float tank's dense salt water solution (created by the addition of Epsom salts) supports the muscular, skeletal and circulatory systems with zero pressure—and for the positive effects of the absence of external stimuli enabled the mind and body to give itself over to complete rest, relaxation and recovery. Given that we live in a world of constant sensory inputs, the benefits of spending time in isolation floating weightlessly has an obvious appeal.

Some of the most profound and interesting research on Floatation-REST was release in 2018 when Dr. Justin Feinstein of the Laureate Institute for Brain Research (LIBR) in Tulsa, Oklahoma, USA published a peer-reviewed study on the use of floatation for treating severe mental issues, including PTSD, panic disorder, depression, agoraphobia and other forms of anxiety. Because Dr. Feinstein recognized that patients

Open floatation tanks are a great addition to any spa or hydrothermal area, offering guests a unique experience that requires minimal staffing.



Courtesy: Floataway

that already suffered from anxiety could perhaps be made more anxious if asked to enter an enclosed pool or pod, his research is based on open round pools—marking the first time this type of floatation tank has been validated in a study.

The results were impressive—after a single one-hour float, all 50 participants in the study reported a strong reduction in anxiety and stress-related disorders. Beyond the immediate reduction in anxiety, the float experience also induced a significant decrease in self-reported stress, muscle tension, pain, depression, along with a significant increase in serenity, relaxation, happiness, positive affect, overall well-being, energy levels and feeling refreshed.

Dr. Feinstein’s peer-reviewed paper can be accessed here: <http://journals.plos.org/plosone/article?id=10.1371/journal.pone.0190292#sec017>.

New research shows a deep drop in anxiety levels after a 1-hour float. The study measured notable improvements in participants who considered themselves anxious and non-anxious.

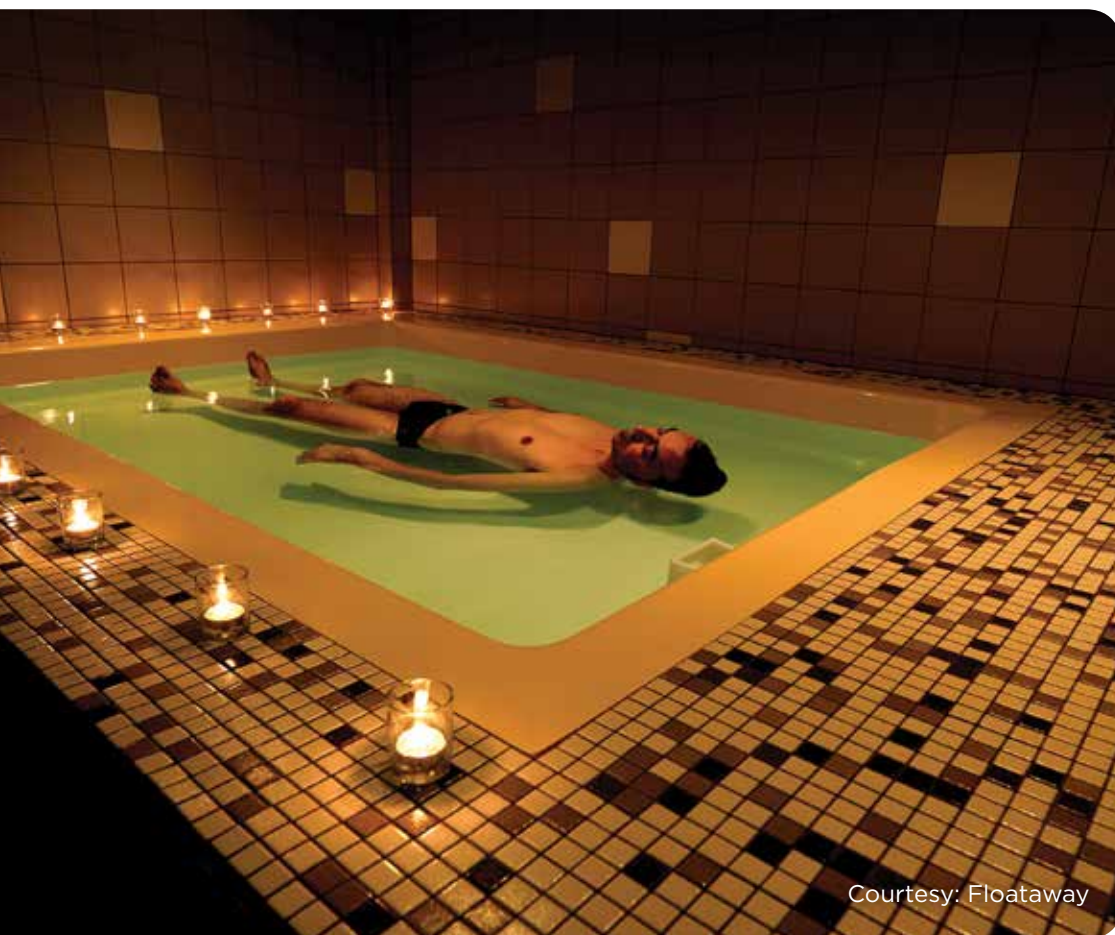
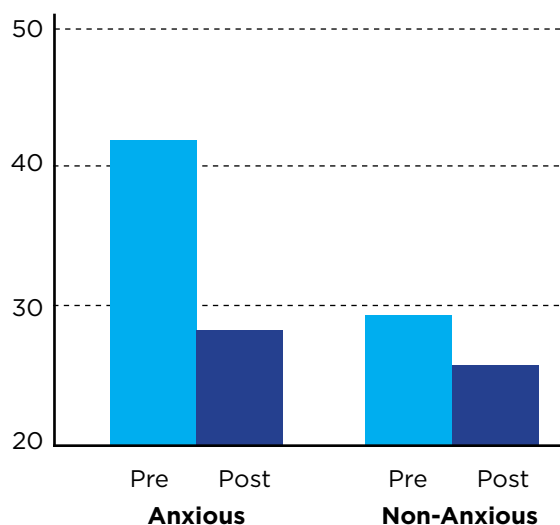

Courtesy: Floataway

The buoyancy of a floatation tank and the absence of external stimuli helps the body and mind give itself over to complete rest, relaxation and recovery.

Further Resources

There is a wide world of evidence on the effectiveness of wellness therapies to explore. In order to start your research, try these resources:

Contrast Water Therapy

www.ncbi.nlm.nih.gov/pubmed/23626806

Hydrotherapy for Depression

www.psychologytoday.com/blog/inner-source/201407/cold-splash-hydrotherapy-depression-and-anxiety

Hydrotherapy in Heart Health

[www.internationaljournalofcardiology.com/article/S0167-5273\(14\)02069-5/abstract](http://www.internationaljournalofcardiology.com/article/S0167-5273(14)02069-5/abstract)

Hydrotherapy in Stroke Rehabilitation

www.ncbi.nlm.nih.gov/pubmed/26130657

Benefits of WATSU in Third Trimester of Pregnancy

www.ncbi.nlm.nih.gov/pubmed/25815033

Reducing Pain in Fibromyalgia

www.ncbi.nlm.nih.gov/pubmed/25000940

Hydrotherapy Improves Balance in Parkinson's Patients

www.ncbi.nlm.nih.gov/pubmed/24895382

Hydrotherapy Improves Gait in Spastic Paraparesis

<https://www.ncbi.nlm.nih.gov/pubmed/24556467>

Hydrotherapy and Social Engagement in Autism Spectrum

www.ncbi.nlm.nih.gov/pubmed/24520196

Recovery After Exercise

www.ncbi.nlm.nih.gov/pubmed/23246445

Enhanced Recovery After Exercise with Hydrotherapy

www.ncbi.nlm.nih.gov/pubmed/18058595

Hydrotherapy Reduces Pain in MS Patients

www.ncbi.nlm.nih.gov/pubmed/21785645

Hydro-rehab in Knee and Hip Arthritis

<http://onlinelibrary.wiley.com/doi/10.1002/14651858.CD005523.pub3/full>

Floation-REST for Treating Depression and Anxiety

<http://journals.plos.org/plosone/article?id=10.1371/journal.pone.0190292#sec017>

Altered Consciousness in Sensory Deprivation

www.nova.edu/ssss/QR/QR13-4/kjellgren.pdf

Floating and Muscle Tension, Stress

<http://bmccomplementalmed.biomedcentral.com/articles/10.1186/1472-6882-14-417>

Aromatherapy Studies

www.wellnessevidence.com/wellnessevidence/aromatherapy/spotlight



Project Planning: Architecture & Design

This chapter gives readers a broad overview of what to consider during the planning and building stages of a residential or commercial spa. It is designed to help the reader understand what goes into the build and how to prepare for it, including assembling a project team. It outlines some of the major oversights and how to avoid them.

Perhaps surprisingly, one of the most significant stumbling blocks in the planning of a hydrothermal spa area—whether it’s commercial or residential—is a misunderstanding of basic terminology and functionality. There can be a lot of confusion around what each of the thermal cabins does (i.e., are they dry or wet? hot, humid or cold?) or how a pool functions. Because terminology can differ from country to country, the confusion is often escalated. For example, what’s the difference between a hamam and a steam room? a sauna or a banya? or a steam shower and an experience shower? If the whole team does not “speak” the same language, it becomes impossible to deliver to a client’s expectations.

This guide will help minimize these issues by providing clear definitions of the hydrothermal features that are typically included in a modern build. The reader will find detailed descriptions of thermal rooms and other specialist treatment rooms (see Chapters 4 and 5) and



Courtesy: Barr + Wray Ltd.

During the initial client briefing, the entire scope of the project—including reception area requirements—will be discussed.

hydrotherapy pools (see Chapter 6), as well as a glossary of key hydrothermal terms. However, it should be noted that this is only a starting-off point, and, regardless of the size of a build, it is always recommended that a hydrothermal specialist be appointed at the outset of the project. Without a hydrothermal specialist on the team, there will always be a risk of overlooking some very basic requirements that could ultimately end up costing both time and money.

Assembling a Project Team

A commercial build requires not only a hydrothermal specialist but it is also vital to engage an architect and interior designer, preferably with spa experience. In addition, an operational spa consultant should be a key part of the team. They will help create the business plan; plot the flow of guests through the spa; assist in choosing the products and services required; and coordinate staff recruitment/training, etc.

A proactive client will listen to his/her team's advice, but will also be prepared to question it. It's highly recommended that anyone embarking on such a project makes numerous spa visits, including to spas that members of the team have designed, operated, built or consulted on. If possible, speak to other spa owners/operators to identify critical success factors and the things they may have done differently. A hydrothermal spa based on a single team member's

personal tastes or operating experience is usually a recipe for an unsatisfactory project. Instead, a spa that meets an owner/operator's vision, while incorporating industry best practices and unique customer selling points is the ultimate desired outcome.

In short, hydrothermal spa design is a complex process that requires a specialist designer with expertise in both design and engineering and who has a unique understanding and appreciation for integrating both into a single space. Typically, lead designers on large commercial projects will employ a specialist sub-consultant to carry out the spa design.

Commercial Spa Design Stages

The design stages of a project are typically as follows:

- 0 – Definition
- 1 – Prep and Brief
- 2 – Concept Design
- 3 – Schematic Design
- 4 – Detailed Design
- 5 – Construction Documents (can include Bid Documents)
- 6 – Construction
- 7 – Handover and Close Out
- 8 – Operational

Stage 1: Preparation and Client Briefing

The project team meets with the client to ascertain requirements, unique selling points (USPs) and overall vision. The briefing should cover these basic points so that the team understands the basics of the build:

- Architectural space allocated to spa area
- Cultural/regional requirements
- USP's – Signature spaces/treatments
- Reception requirements
- Retail space needs
- Spa food & beverage (F&B) offering
- Number of treatment rooms
- Relaxation space
- Changing rooms
- Wet areas (pools/thermal cabins)
- Back of House (BoH) requirement – offices; prep areas; pantry/linen storage

Stage 2: Concept Design

Step 1: Adjacency Plans (also known as 'bubble diagrams'), including:

- Architectural space (access points, lifts, and views)
- Guest flow/journey (considering male, female and disabled guest)
- Staff flow (discreet staff movements for guest privacy)

Step 2: Concept Design

This is the first time that the client will be able to visualize their spa design, including:

- Reception layout including consultation space (privacy)
- Retail space
- Spa F&B
- Changing rooms – locker/WC's/vanity areas
- Wet area design – types of pools & thermal cabins (avoiding cross over from wet to dry areas)

Typical Adjacency Plan

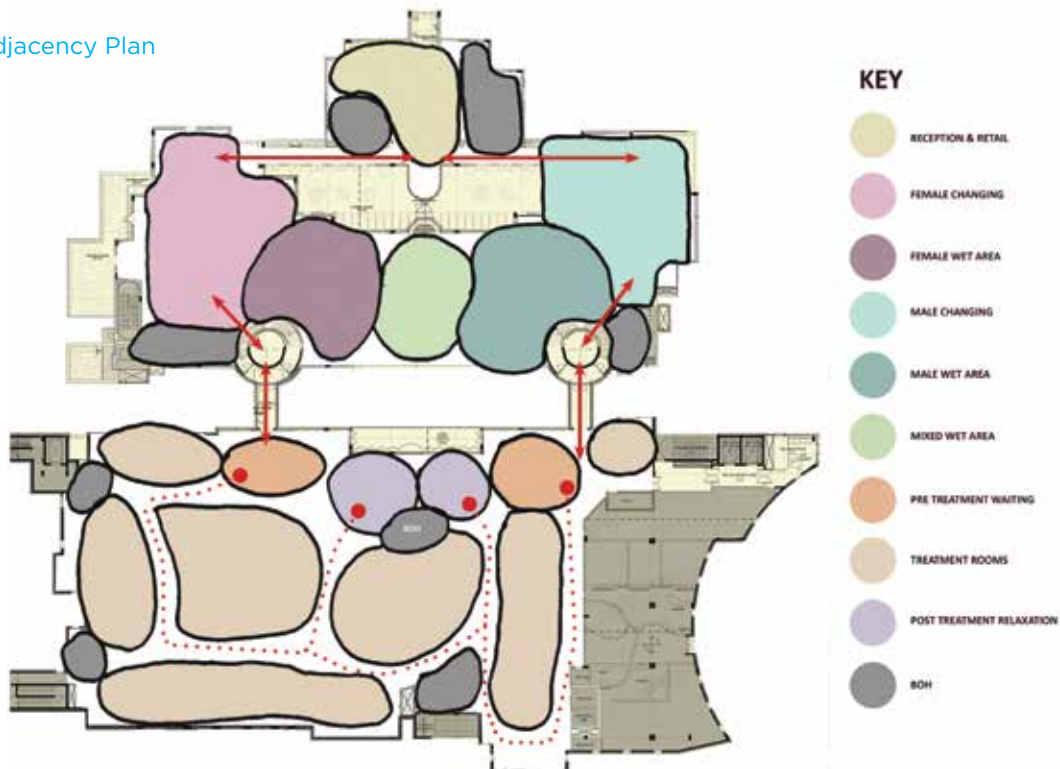

- Treatment rooms and types (single/double/VIP)
- Relaxation space – loungers/beds
- Plant room requirements
- Back of House (BoH)
 - Office requirements – spa director; administration; reservations
 - Prep areas/dispensary
 - Pantry
 - Clean & dirty linen distribution
 - Storage space
 - Cleaners’ storage
 - Plant room/technical room

During this phase, the hydrothermal specialist will also consider areas where the client can maximize revenues, including:

- Flexibility to swing or change male/female occupancy depending on demand
- Special chargeable treatments (e.g. Rasul mud bath or hamam)

Two major areas the hydrothermal specialist will bring to the attention of the client at this stage of the design development is:

- Ensuring integration with general building MEP requirements (best achieved if project is utilizing the latest Building Information Modeling (BIM) design software)
- Plant room size and location
 - Optimize plant room size but ensure sufficient space to allow for future plant maintenance
 - Plant/Mechanical rooms should never be located near quiet relaxation areas.
 - Plant/Mechanical rooms should be located near the pools (beneath the water level) and thermal cabins
 - Electrical loading and MEP requirements: Power/Water/Drainage/Ventilation
 - Sustainability – LEED/BREEAM requirements may have to be considered
 - Technical equipment selections

Typical Concept Plan

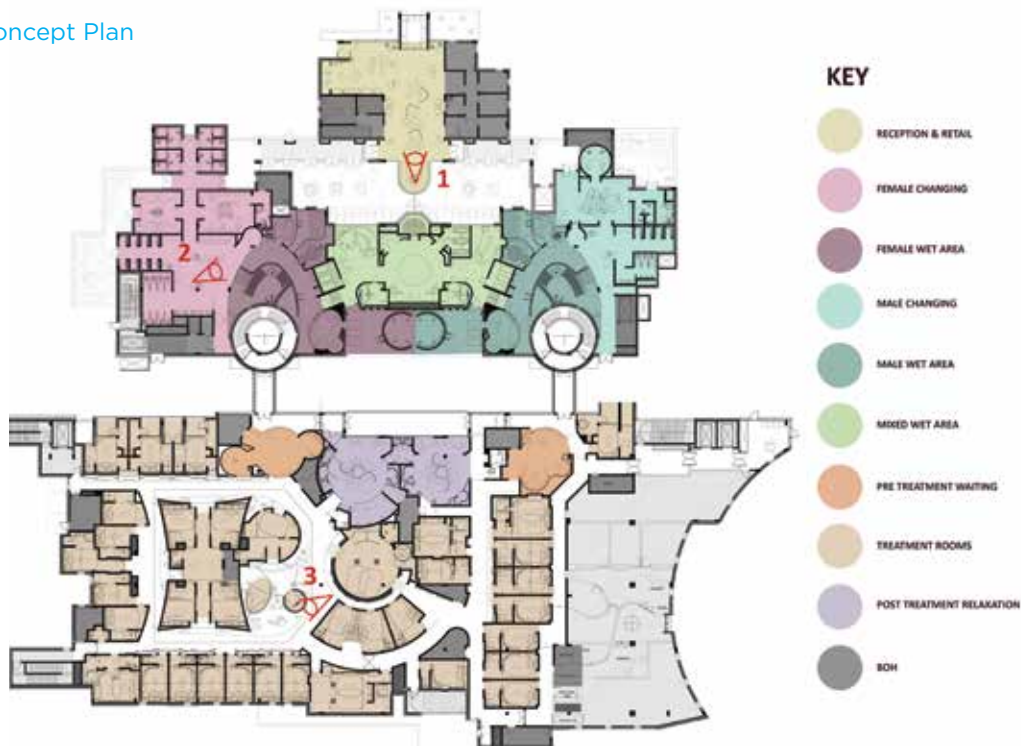

Renders of all spa areas helps a client visualize the final spa design.



Step 3 – Mood Boards & Samples

There should be careful consideration of finishes and materials in wet areas.

- Avoid soft stone materials that absorb water
- Consider any potential slip hazards
- Potential oil stains should be taken into consideration when choosing fabrics

Stage 3: Schematic Design

At this point the project drawings will ‘prove’ the concept design and ensure everything fits into the building. Also at this stage the hydrothermal/spa design specialist should provide a schedule of costs with budget/target prices to assist the client to finalize his overall budget for the project.

Computer generated images (CGI renderings) will frequently be created at this stage to allow the client to fully visualize the finished spa.

Stage 4: Detailed Design

Detailed design starts with refining the schematic design and then providing the client with a complete set of drawings, room data sheets and schedules for doors, ironmongery, sanitary ware, feature lighting, finishes

and furniture fittings and equipment. Completion of this is frequently referred to as “100% DD.”

Stage 5: Tender & Construction Documentation

Once the client has approved the detail design then a full package of drawings, specifications and schedules is prepared with status “Issued for Construction” (IFC).

Additional services can also be provided by the hydrothermal/spa design specialist, including:

- Responding to tender queries from specialist spa fit out contractors
- Reviewing tenders from specialist spa fit-out contractors
- Participation in tender clarification meetings
- Prepare tender evaluation report and recommendations

Stage 6: Construction Supervision

Visit site on a regular basis to ensure that the spa installation contractor complies with the design specification and witness final testing and commissioning of all equipment, particularly in the wet areas.

Specialist Hydrothermal Team

Don't underestimate the complexity of the building services associated with a wet spa. Even if the architect and interior designer have been involved in this type of build before, it doesn't necessarily mean they have the detailed expertise required to properly execute these critical areas.

A successful build is based on collaboration between the design/construction team and a specialist wet area team that will bring detailed knowledge of hydrothermal spa requirements. Regardless of the size of the project, wet spa equipment supplier(s) and consultants should be selected at the outset of the project, so their specific requirements are communicated to the design/construction team in order to create a successful project through the conventional design phases as outlined above.

It's important to identify early in the process who is in charge of the coordination of the various subcontractors. Ideally, this is a project manager who is able to oversee the other contractors and has an understanding of wet area specifications, such as the type of insulation and

waterproofing that are necessary; as well as providing insight into the pipe work, sprinkler systems, concrete works, plant rooms, plinths, balance tanks, etc. These will all be installed by various contractors, but the wet area specialist should help get the basics right—such as the floor slab, its water proofing and slope—correct the first time around.

For a large commercial build your hydrothermal team will look like this:

- **M&E or MEP consultant:** all mechanical and electrical interfaces, including ventilation, plant room, drainage, etc.
- **Structural engineer:** works on the details of all major building works, including pool structures and prefabricated cabin rooms, etc. (can be part of the architectural team)
- **Hydrothermal equipment provider:** can work with a hydrothermal specialist or independently to advise not only on equipment required but also on the layout of cabins, pools and people flow and will ensure plant/mechanical rooms are properly provided for



A hydrothermal team will ensure that all wet areas in a spa are well planned out and installed correctly.

Sample Spa Flow

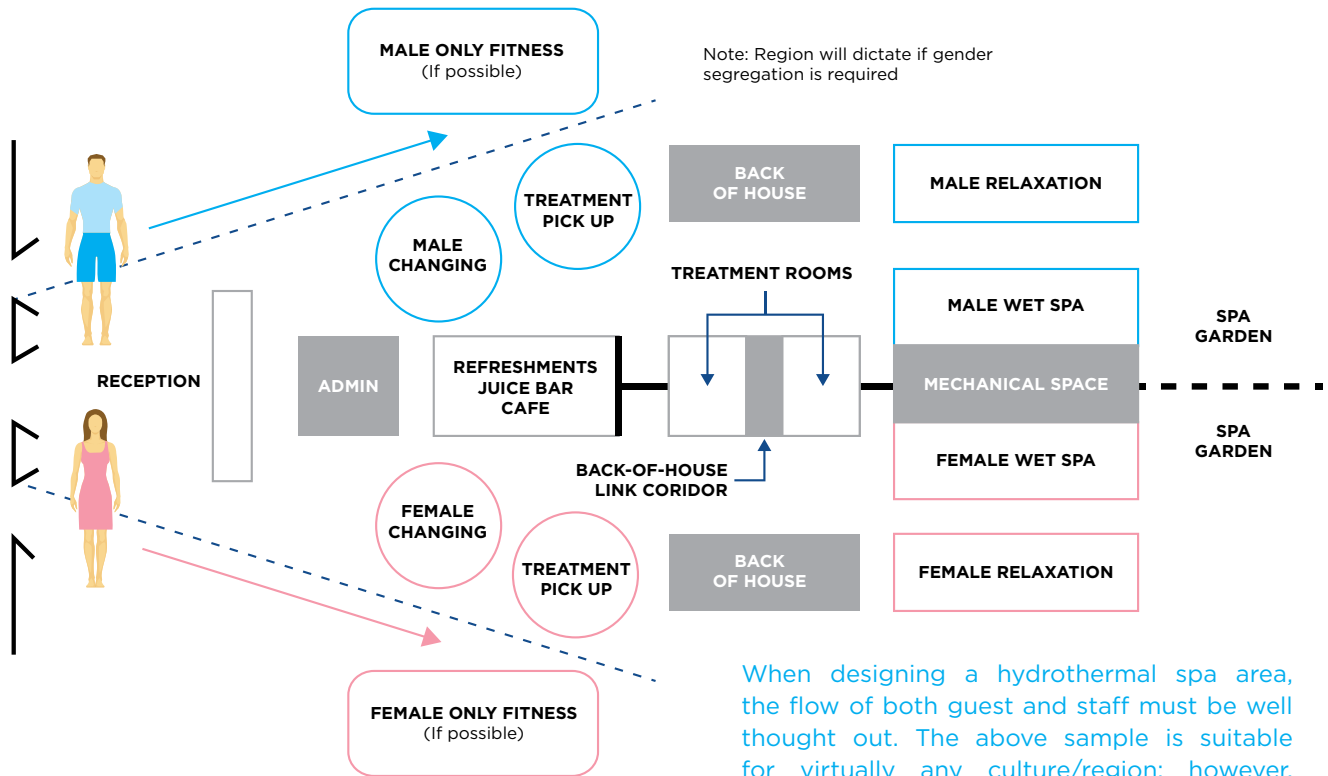

When designing a hydrothermal spa area, the flow of both guest and staff must be well thought out. The above sample is suitable for virtually any culture/region; however, it's becoming more common to have mixed gender relaxation and spa areas.

Space and People in Commercial Spas

The most crucial considerations in a new build are space requirements and people flow. A common error is underestimating the space required for the plant room and mechanical equipment. For example, a simple hydrotherapy pool may not look too big, but it requires almost as much space again for the associated plant and equipment. On the other hand, a Finnish sauna needs next to nothing in terms of additional space, unless it features an automatic essence dosing system, which requires its own plant cupboard.

Consideration for people flow (both for guests and staff) is also critical. Staff should have a completely different flow from guests so they can perform behind-the-scenes functions without being seen, like setting up treatments, gathering used linens and cleaning. Generally, the way people interact in hydrothermal

areas differs greatly from the way they would interact in other public spaces. It's important to be aware of the need for extra personal space.

Additionally, the intense heat of the thermal treatments means that space must be allocated for cooling off (through showers and plunge pools) and relaxing between treatments. As an example, 10 minutes in a sauna requires 20 minutes to 30 minutes cooling time (of course, in practice, people will listen to their bodies and these times will vary significantly). Space should be allocated accordingly—if, for example, the thermal cabins in a spa seat 15 people, then the relaxation/cooling areas need to accommodate at least the same number, if not more, people. The customer journey through the spa should also be logical and simple to follow.

Spa Suites

Spa suites enable guests to enjoy different types of spa applications in relatively luxurious environments, normally attracting a premium price, without having to move around the spa. So, in addition to the positive effects of the treatments, the guest is more relaxed because they will have the luxury of time to enjoy all the equipment at their leisure.

Spa suites are usually designed as “miniature spa areas” in their own right and can include separate rooms/areas for different treatment types and are often designed to accommodate two or more people. What is included in a spa suite is determined by the theme of the spa itself and with consideration to guests’ expectations and needs – some common combinations are as follows:



Sample Room 1

- Small hamam area or sauna
- Shower to rinse off and cool down between treatments
- Two relaxation beds for relaxing after having used the en-suite hamam or sauna
 - These beds can serve a double duty by offering a hydro-massage feature, a fully automatic underwater massage.



Sample Room 2

- A fully automatic massage tub for hydro-massage
- A dry floatation bed used mostly in combination with body wraps
- An anteroom accessible via connecting doors with a sauna/hamam and two relaxation/massage beds.

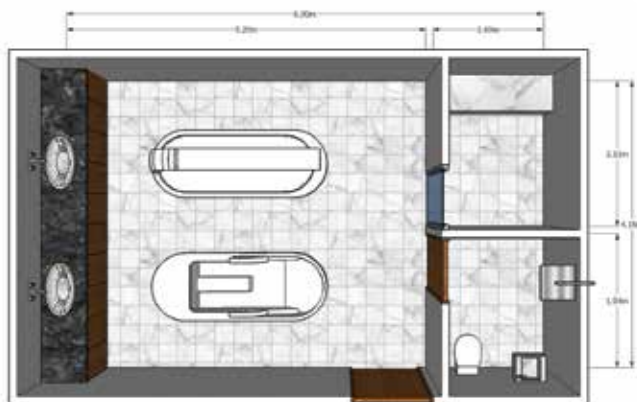

Sample Room 3

- Overhead Vichy/horizontal shower table that can also be used to apply body wraps or dry massages.
- A fully automatic Hydrotherapy tub for underwater massages

Key Considerations

- Seek professional advice early—these are specialized areas; wet area specialists are required
- Be clear on budget—a wet area is not a place to cut corners; understanding this at the outset will minimize frustrations
- Know your audience—preferences around the world vary greatly so make sure hydrothermal features are targeted to your audience
- Balance is important—achieve the correct balance between water (pools) and thermal experiences (steam rooms, saunas, etc.)
- Don't underestimate space requirements—wet spa areas often require twice the space to accommodate behind-the-scenes equipment and maintenance
- Bathers and staff require different flows—understand who will be using and working in the various spaces and plan accordingly
- Don't forget the plant room and equipment—the detailed plant and technical equipment requirements (plant rooms, etc.) are frequently undocumented in early planning stages; this omission often means going back to the drawing board partway through a build—with consequent time delays and extra costs
- Noise is the enemy—customer relaxation will be non-existent and the ambience of the spa will be severely compromised if noise emissions aren't kept to a minimum (for example, a relaxation space should not be adjacent to a vitality pool, which can be quite noisy and often generates conversation)
- Water egress is also the enemy—a lack of detailed planning in the materials used, construction techniques and drainage can result in water leakage/damage throughout the facility, which can lead to health issues from mold and bacteria growth such as legionella



Common Mistakes

- Delays and re-fits—i.e., additional costs—are usually caused when a wet area specialist is not involved during the preliminary design stages
- Underestimating/ignoring space required for plant room and mechanical equipment
- Lack of attention to people flow—both of guests and staff
- Not accounting for variances in cultures and the types of treatments and facilities guests will want and use (i.e., know your target audience)
- Noise is the enemy of a relaxing spa experience; whether it's a hydrotherapy pool or a plant room operating a steam room—put them where they can't be heard
- Lack of back of house areas
- Building with substandard materials that can't handle extensive heat and moisture
- Failing to follow proper drainage and ventilation standards
- Lack of awareness of health, safety and hygiene in every aspect of the design
- Attempting to cut costs by not hiring dedicated specialists, such as MEP consultant or structural engineers; invariably this will cost more money in the long run
- Not specifying properly tested and certified waterproof construction materials
- Not planning for the space required for the plant room
- Inefficient crossover of wet and dry areas
- Failure to maximize operator revenue

Return on Investment (ROI): Model Hydrothermal Project

When designed as a major feature of a spa or wellness center, wet areas can be significant profit centers. To help readers understand the numbers behind a typical hydrothermal project and to illustrate revenue potential, we have laid out the relevant numbers. The financial example on the adjoining page is in \$USD and based on 2018 values. The prices are for a 4-star resort property and are indicative of costs/revenue builds in North America, the Caribbean and much of Europe and the Middle East. (Excludes any additional costs from specialty finishes.)

Unlike wet areas traditionally installed as locker-room amenities and provided free of charge (delivering minimal ROI), dedicated hydrothermal areas can generate significant profits—and increase guest’s satisfaction and enjoyment with their stay—in a relatively fast timetable.

Advantages of Dedicated Hydrothermal Spa and Wellness Area

- Additional revenue opportunity
- At check-in, staff can easily upsell at a special “buy now” discount
- \$45 entry fee will likely be lowest priced item on spa menu
- Low-cost DIY experience is a great way to get appeal to new spa goers
- Entry fee can be inflated to enable generous discounts to longer staying guests or as a negotiating item when closing corporate or convention business
- Comping hydrothermal area entry for VIPs incurs minimal out-of-pocket expense, leaving treatment room and therapist available for paying guests



A well-planned hydrothermal area not only generates significant profits but also delivers increased guest satisfaction and enjoyment.

Spa Features

- Male and female gender segregated areas
- Sauna, steam room, laconium, snow room, foot spa, cool down showers, hydrotherapy pool and wet lounge area for resting between periods in thermal areas
- 230 m²/2,500 ft² per gender = 460 m²/5,000 ft² total area including circulation space

Note: For simplicity, square footage has been used in the financial example (1 m² = 10.76 ft²). Locker rooms are excluded as they rarely are required in destination resorts as guests arrive in robes. This also excludes general building services to the common areas—all of which would be necessary regardless of what the space was used for. Costs include all technology and feature-specific building services and equipment, such as HVAC, specialist lighting within each experience, and all electrical and plumbing supplies required for mechanical/plant rooms.

Estimated Building Costs	
Complete Installation	5,000 ft ² × \$400/ft ² = \$2,500,000
Wall, Floor & Ceiling Finishes	18,500 ft ² × \$50/ft ² = \$1,000,000
Grand Total	\$3,500,000

Estimated Spa Revenue	
Attendance Per Day	40 guests, 3 times a day = 120 guests (This size spa can easily support 60 guests at any one time, but let's assume we have just 40 guests every 4 hours during a 12-hour day.)
Revenue Per Person	\$45 (The average charge is \$65, but we're using a reduced rate.)
Total Daily Revenue	120 guests × \$45 cost/person = \$5,400/day
Total Yearly Revenue (360 operating days)	\$1,944,000

Estimated Operational Costs	
Staffing Costs	35% to 50% of Spa's Total Income (Staffing levels of hydrothermal areas are very low—no expensive therapists or down time. Just spa attendants keeping space clean.)

Estimated ROI	
ROI with Construction	22 months (less than 2 years)
Total ROI	33-44 months (Given the average life of a hydrothermal spa is at least 12 years, there is a significant return on the original investment by charging a modest \$45 entry fee.)



Courtesy: Barr + Wray Ltd.

Because of the limited space of a residential spa, professional planning is key to ensure space is used efficiently.

Residential or Private Spa Design

Whether it's intended for a home or a luxury hotel suite, smaller spas should, ideally, be designed to the same specifications as larger, commercial spas—simply on a smaller scale. Limited space means that the amenities included in a smaller spa will obviously be a personal decision, however, typically, there will be a steam room or sauna or a combination of both and perhaps a hot tub and some form of cooling experience such as a specialist or multi-feature shower.

Clearly, space is the biggest consideration here and clever planning is needed to achieve the spa area that is desired. Combined solutions, like a steam shower that also serves as a steam room and includes effects like sound, fragrances and light, are a great choice for smaller spaces. And, if possible, a separate relaxation area should be included to get the full benefits of the hydrothermal therapies.

Because of the limited space, professional planning is even more important. You will need sufficient access to all equipment and components for maintenance purposes—something that is often overlooked when

wet areas are not designed by specialists. Of course, the building components, including electrical devices, should be smaller than those included in a commercial build, but it's important to seek out the same quality and reliability as those found in a commercial spa so the wet area will last and maintenance costs over its lifetime will be minimized. A knowledgeable spa designer will look for already-available, prefabricated modular components to build a small steam room, for example. Fitting reliable, high-grade electrical devices and advanced functions as those found in a commercial spa also makes sense—just as you might use a home version of the Italian espresso machine found at your local café or coffee house.

Automation is another big area of consideration for a residential spa. Technical standards are constantly evolving but being able to operate your spa via an app on a smartphone or other device will make a residential spa experience much better and in sync with current trends in home automation. To learn more about creating a connected, smart spa, see Chapter 8.

Private Hydrothermal Areas: Design Concepts

Designing hydrothermal areas for private use requires clever planning due to limited space. Here, and on the following page, are two different concepts—both are open-planned designs, including glass fronts for the sauna steam rooms. In addition, because it's an intimate living environment, the rooms also include more space for lying down versus sitting—so the benches are wider where possible; and, to maintain proper hygiene, large surface tiles are used. Both private hydrothermal spa areas are approximately 30 square meters.

Private Spa Design Concept A

Includes heated relaxation loungers; sauna; walk in shower; steam room with heat-storing ceramic benches.

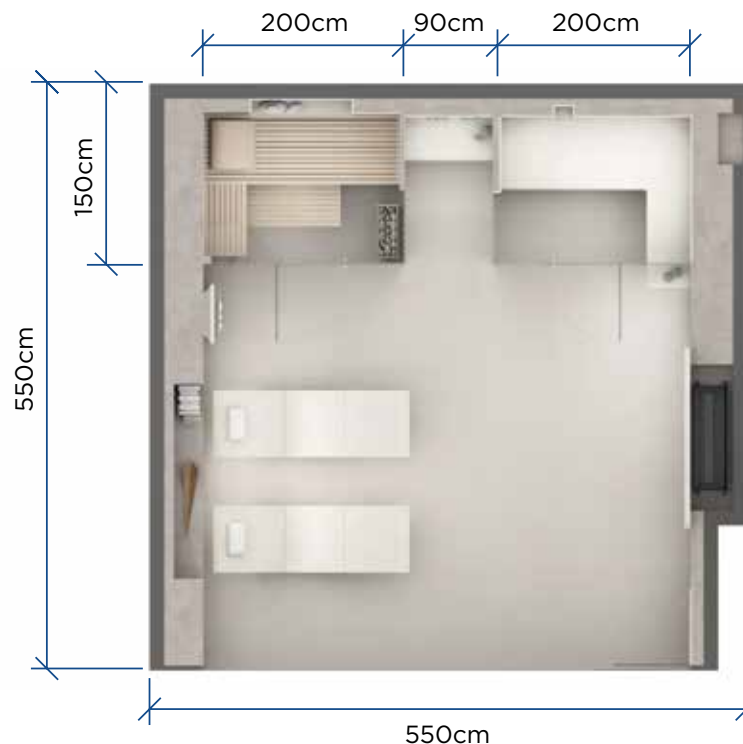



Courtesy: Sommerhuber

**Private Spa Design
Concept B**

Includes heated relaxation loungers; traditional sauna; steam room with an ergonomically shaped heat storing ceramic bench and floating lounger; walk in experience shower.

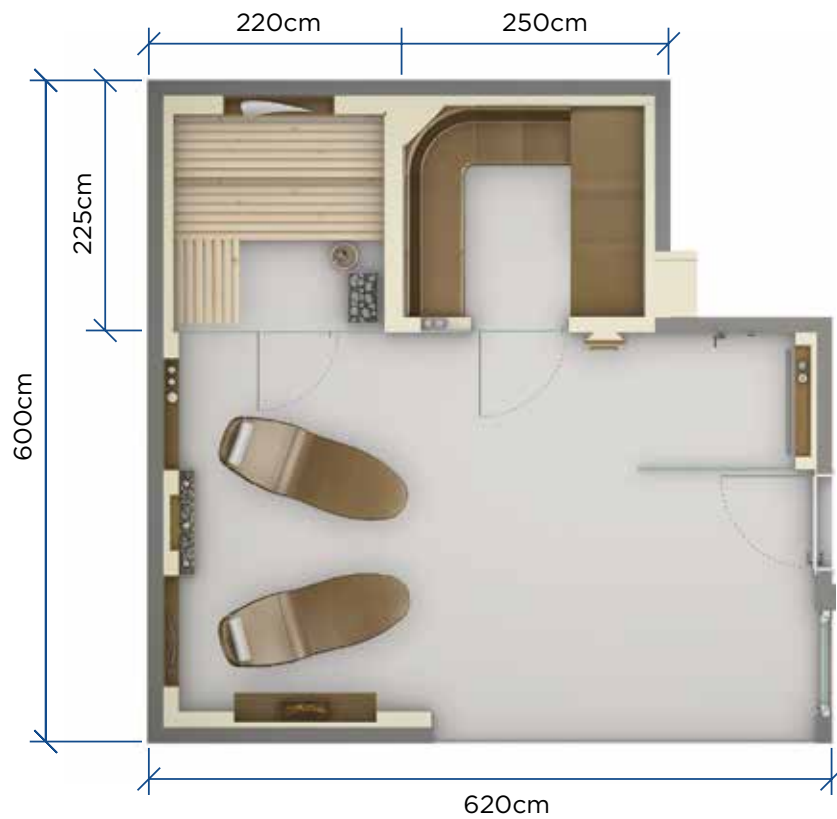

International Codes and Standards

Regardless of the country a project is based in, there are internationally accepted codes and standards that hydrothermal specialists follow (be sure that your architect or builder is aware of them). In addition, you should consult relevant local codes and guidelines before proceeding with a build. Below is a list of commonly used codes and standards used in professional hydrothermal builds.

General Building Codes/Standards

Americans with Disabilities Act (ADA): The disability code adopted by most builders/architects internationally; www.ada.gov

German DIN 18040-1: German barrier-free building standards for disabled access; www.en.lehnen.de

International Building Codes: Developed by the International Code Council, a U.S. organization that is dedicated to developing model codes and standards used in the design, build and compliance process to construct safe, sustainable, affordable and resilient structures. These codes are adopted globally; visit www.iccsafe.org

RIBA Plan of Work: The Royal Institute of British Architects champions better buildings, communities and the environment through architecture; provides standards, training and support for architects; www.architecture.com

Sauna and Steam Room

German Sauna Standards: Created by the RAL standards authority; www.ral-guetezeichen.de

ÖNORM M6219: Austrian standard for planning and operation of steam rooms; www.bdb.at

Swimming Pools and Surrounding Area

BS EN 13451-1:2011, Swimming Pool Safety Requirements: UK standards for general safety and testing of swimming pools and pool equipment; available at shop.bsigroup.com

German DIN 19643-4: German standards for swimming pool water and bath water hygiene; available in English at www.beuth.de

German DIN 51097: German standards for slip resistance; www.beuth.de

Pool Water Treatment Advisory Group: A UK organization dedicated to raising standards in swimming pool water treatment; www.pwtag.org

International Swimming Pool and Spa Code (ISPSC): Developed with the Association of Pool & Spa Professionals (APSP), the ISPSC establishes minimum regulations for public and residential pools, spas and hot tubs; <https://www.iccsafe.org>

Trade Rules of the Swedish Ceramic Tile Council for Wet Areas: Best practices adopted by most hydrothermal experts for installing ceramic tile; www.bkr.se



Thermal Bathing Areas: Function and Design

.....

This chapter focuses on thermal bathing cabins and rooms (such as saunas and steam rooms) found in a typical modern spa. It includes a comprehensive overview of the functionality and health benefits of the different types of thermal cabins and outlines special considerations required to create spaces that not only please the user, but also comply with accepted health and safety regulations.

.....

First, we look at some of the guiding principles to follow for ensuring these spaces account for the way people typically interact within them. Design considerations are demanding for the simple reason that users are minimally clothed and are using areas that are both warm and wet, presenting hygiene and safety issues (see Chapter 9).

Human Interaction

When conceiving these areas, it is essential designers understand people fundamentally interact differently when they have few or no clothes on—personal space, in particular, becomes of the utmost importance. The way we interact in a bathing suit or completely naked is very different to how we generally interact in public spaces. Take, for example, public transport—here people often touch strangers, sitting thigh-to-thigh or standing shoulder-to-shoulder on a subway or a bus. By contrast, sitting and touching bare-thigh to bare-

The consideration of personal space is very important when designing thermal bathing areas.

thigh in a sauna or steam room would be unacceptable for most. It seems obvious, but not accounting for the increased need of personal space is one of the biggest mistakes made in a hydrothermal construction project.

In practice this means creating wider hallways in order to avoid any “pinch-points,” where people must squeeze past one another; designing benches and seats to allow for adequate space between bodies (600 mm is recommended); and, where possible, providing individual seating so that bathers don’t have to consider invading another’s personal space on a communal bench.

If you’re designing a co-ed (mixed male/female) area, there are other considerations. For example, a standard practice when designing steam rooms and saunas is to include a clear view into the cabin so bathers can see exactly what is happening inside, including gauging the number of current occupants. A woman bathing on her own, for example, may not feel comfortable entering a busy sauna if there are only men inside. She may prefer to wait until some of the group exits or until other women enter the cabin.

Surfaces and Flooring

The surface finishes in all areas of the hydrothermal spa should be chosen based on how well they will accommodate the users. For example, instead of traditional mosaic tile, consider larger slabs of stone or tiling to avoid grout lines every few inches—and to minimize the effects of wear and tear caused by the water’s properties. Also, avoid soft, porous stone, such as marble, in steam and wet rooms, as it, too, is prone to degeneration. It’s also important to not use very dark tiles so that cleaning staff can easily recognize areas that need cleaning.

The floor finish should be chosen to minimize the potential for slippage. Getting the floor finish and correct sloping angle is crucial for proper drainage, and to avoid accidents in wet areas. In places where a lot of water accumulates, such as those close to pool exits and steam rooms, proper drains and slopes need to be implemented in the screed below. Because the

drainage in spas is very different to any other part of the building, it needs to be addressed in consultation with the wet-spa-area specialist.

Entries and Exits

Being able to easily enter and exit cabins is paramount. For example, in the event of a bather feeling unwell, he/she should be able to leave the cabin unhindered. This means doors must always open outwards and be free of any mechanical latching devices.

Disabled Access

Access for people with disabilities has become increasingly important in all builds, and the hydrothermal spa area is no exception. Providing this access is not only a law in some countries, but it’s also a sign of inclusiveness and enables the facility to market to a broader number of people. And, the benefits of hydrothermal treatments to disabled persons, particularly with motor or physical disabilities, make providing access even more important.

In broad terms, disabled access means incorporating the following basics:

- Entry ramps
- Correct door widths
- Correct clearances on the pull and push side of doors
- Low-level emergency button inside the room for assisted exit
- Low-level bell at entrance to request assisted entry
- A disabled bathroom
- Accessible changing and locker rooms, shower areas
- Treatment rooms on the ground floor and/or lifts to upper floors
- Wheelchair access to treatment rooms (corridors, doors, turning radiuses)
- Hydraulic treatment tables

Laws related to disability are enshrined in statutes, such as the Disability Discrimination Act in the UK and the Americans with Disabilities Act in the U.S. These (and others) prohibit discrimination against people with disabilities, which can be visible, hidden, permanent or temporary.



Hot and Dry: Finnish Sauna/Russian Banya/Bio Sauna/ Infrared Sauna

Finnish Sauna

Temperature: between 70° C to 95° C

Humidity: 5% to 15% at level of second bench; 3% to 10% at level of third bench

Russian Banya

Temperature: between 80° C to 105° C

Humidity: 60% to 70%

Biosauna (or Soft Sauna)

Temperature: between 50° C to 60° C

Humidity: 45% to 65%

Infrared Sauna

Temperature: between 32° C to 35° C

Humidity: 55%

There are several different styles of saunas in use today. The traditional and most common are Finnish saunas and Russian banyas (“banya” actually means “bathhouse” in Russian, but the term has been adopted to refer to the sauna-like room in the banya). While various sauna types all run at slightly different temperatures and humidity, they are closely related in style, usage and health benefits.

How Saunas Work

A heat source radiates warmth from wood-clad walls via stones that are heated in an electric or gas sauna stove, or, in traditional installations, by log fires.

Saunas typically have two or three different levels of benches to provide room for as many people as possible and also offer varied temperature zones—as the heat will be significantly stronger at higher levels. The benches are wooden and constructed of specialist timber that is chosen for its low thermal conductivity and high laminar strength. The benches have a lattice design with broad slits to allow the air to circulate well throughout the sauna.



Saunas are the hottest therapy cabins in a hydrothermal spa and likely the one most bathers will already be familiar with.

Infusions of water bring out an increase in humidity, subjecting the body to a short, but powerful, heat stimulus. Traditionally, a small wooden tub full of water and a ladle was used to pour water over the hot rocks. In addition, the water was often infused with birch twigs to give it a pleasant fragrance—birch was also believed to improve the immune system and open skin pores. In modern installations, automated water dosing systems are often used, and the infusions are typically oil essences in a wide range of scents that offer different aromatherapy stimuli for body and mind. In addition, there are safety and efficiency benefits associated with automated dosing systems, including the avoidance of over-dosing fragrance and controlling the amount of water that is used, preventing unnecessary wear on the heat source and avoiding any water puddling.

Type of Use

Saunas are traditionally used to relax and ease muscle tension, as well as boost circulation and improve the immune system.

As one of the hottest therapy cabins in the hydrothermal spa, saunas should be used in conjunction with cold—this can be anything from a cold shower, an ice fountain or a “roll in the snow” in a snow room or via a snow

shower. A warm, ankle-deep footbath (outside the sauna cabin) should also be considered for equalizing body temperature. (The small amount of flesh and fat on the feet, combined with a large number of blood vessels, allows them to get cold and hot faster than any other body part, so a footbath will help regulate the body’s temperature.)

Health Benefits

The alternation of heat and cold (also called contrast therapy) ensure that a good supply of blood is pumped through the veins, helping to flush out toxins from areas of the body that aren’t normally given the ability to do this (namely the skin and subcutaneous tissues). The immersion in both hot and cold is also believed to train the immune system, and regular sauna users rarely suffer minor infections and colds.

Heat Source

Sauna Stove: Heat comes from specially sourced stones—typically deep igneous, plutonic rocks capable of absorbing and emitting high levels of heat. They are heated in the sauna stove, traditionally by a wood fire but, more often, by electricity or gas. The size of the sauna stove is determined by how many kilowatts

per cubic meter of heat is required—a calculation that must be done by a wet-area spa specialist. For example, the power requirement of the heater increases if the sauna has any windows or if glass is used within the design in general. If this is the case, there can be a potential health and safety issue for guests.

Materials/Construction

Structure: A soft, sustainable wood that is resin-free is recommended in classic sauna design—common choices are pine, hemlock, spruce and cedar. When choosing wood, note that minimal knots are preferred, as they can act as hot spots and cause uneven heat radiation.

Benches: A hard, low-thermal-conducting wood is required for the benches. Aspen, obeche or poplar are good choices, as they will not split and conduct minimal heat so will avoid burning the skin. Benches should support a minimum of 200 kg/440 lbs per linear meter or 134 lbs per linear foot.

Ceiling: Should not be higher than 226 mm above the head of the bather when sitting on highest bench.

Door: Traditionally made of wood, but design trends have moved towards all glass (must be tempered safety

glass). Door sizes can vary depending on application and building codes, particularly in relation to access for the disabled. Interior door handle must be wood so it doesn't become too hot to the touch.

Windows: Though not traditional, windows and/or glass fronts are becoming more common in modern saunas. Of course, this can change the level of insulation and radiation provided by an all-wood cabin; however, they have architectural and aesthetic merit and can allow bathers to feel more comfortable by delivering more visibility.

Floors: Saunas should be constructed on level, pre-tiled floors. If the walking distance between the door and benches is greater than 2 meters, installing a removable wooden floor or underfloor cooling system is recommended in order to keep guests' feet comfortable.

Design Considerations

Size/Space: When designing saunas for commercial applications, consideration should be given to personal space and a minimum of 600 millimeters should be allowed for each person sitting. Bathers also like to lie down in a sauna so it should ideally accommodate a two-meter-long person.

Doors were traditionally made of wood, but now often feature tempered safety glass.



Audio/Visual: Consider both lights and sounds to enhance the experience. In commercial builds particularly, audio is used to help break the often-uncomfortable silence you can have when entering a closed space with strangers. There are heat-proof speakers specifically designed for this usage, as well as specialist equipment that links both light and sound output.

Illumination: Lighting choices are fairly limited in saunas simply due to the fact that it has to be resistant to extremely high operating temperatures, especially in the higher section of the sauna, where heat is strongest. There are specifically designed specialty products available for use in saunas, including sconces, crystal glass diffusers and fiber optic lighting. Standard lighting equipment can also be sourced for installation below the first bench level, as heat is less of an issue.

Ventilation: It is essential that saunas are properly ventilated to keep a continual flow of oxygen in the cabin. An air extractor point is located close to the bottom of the cabin to take the cooler, more humid air

out, usually via a duct built into the wall panel that will discharge the air at roof level. Fresh air will be delivered directly into the heat source, ideally exchanged and refreshed seven to 10 times per hour.

Special Considerations: Users of the sauna must be able to monitor temperature, relative humidity and the duration of their sauna experience. This makes the inclusion of a thermometer, a hygrometer (used to measure moisture content) and a timer imperative (an 'hour glass' measuring appropriate time segments is ideal).

How to Use a Sauna

- A proper sauna session will take 90 minutes
- Remove clothing, jewelry and contact lenses
- Prior to sauna, users must shower and fully dry themselves to remove any film on the skin that can delay the onset of sweating (ideally, a foot bath should be used)
- Once in the sauna, it's ideal to lie down so that the entire body is within the same temperature zone; if you must sit, sit with your feet up on the same bench you are sitting on
- First sauna session should last eight minutes to 12 minutes (depending on how the body reacts); followed by cooling off 12 minutes to 20 minutes
- Cool off first in the air, then rinse off the sweat with cold water
- The first session can be followed by two more sessions, and you will note that your body will visibly sweat more rapidly during the second and third sessions
- After the final sauna session, it's important to rest and cool off your body completely



Courtesy: WDT
Werner Dosiertechnik

Example of an LED spotlight designed specifically for use in high temperature saunas.

A Russian banya is very similar to a sauna in form and function - with a key differentiator: bathers use dried branches to hit themselves to improve circulation.



South Kensington Club Bathhouse (Credit: James Larkin, Cameron Clair)

How to Use a Banya

- A traditional banya will have a washing room for showering before entering the banya
- Remove clothing, jewelry and contact lenses
- Do a five- to 10-minute session, followed by a cooling-off period either outdoors or in cold water
- During the second session (or “second sweat”), veniks, or bunches of dried branches and leaves from white birch, oak or eucalyptus, may be used to hit bathers (this can be done by yourself or another person) in order to improve circulation
- During the cooling-off period, bathers often sit in an antechamber next to the sauna, socializing, playing games and having refreshments



Common Mistakes

- Using the walls of the building when constructing sauna: walls of a sauna must be independent and have a cavity between them and the building walls to avoid condensation
- Installing lighting that is not resistant to the intense heat of a sauna
- Incorrect ventilation that does not provide correct airflow
- Installing door handles on the inside of the sauna made of material that conducts heat; therefore, scorching bather’s hands
- Purchasing a residential sauna for use in a commercial setting—these saunas aren’t designed to the same standards
- Using the wrong building materials so that the sauna doesn’t function correctly or has a short life span



Infrared Sauna

Temperature: between 32° C to 35° C

Humidity: 20% to 35%

Infrared saunas are the least hot of all the sauna types. The biggest difference is the heat they provide—a natural electromagnetic radiation that’s not visible to the human eye. A traditional sauna uses heat to warm the air, which, in turn, warms the body, while an infrared sauna heats the bather’s body directly without warming the air. Infrared heat is used in medical applications, as it is believed to enhance blood circulation and ease muscle tension, while strengthening the immune system and reducing stress.

How Infrared Heat Works

Long-wave infrared radiation is absorbed by the upper layers of the skin and is assimilated just under the surface where the heat-sensitive nerves—the peripheral nervous system—are located. This warmth is then distributed throughout the entire body by the blood vessels and lymph nodes and is comparable to the pleasant warm feeling experienced from the warming of the sun.



Two types of infrared saunas exist. Traditional wood saunas with integrated infrared lamps (top) feature radiation that is primarily in the shorter electromagnetic wavelength of infrared B; while a heat-storage ceramic sauna (left) emits longer infrared C waves. Experts suggest that shortwave infrared is better for curing specific physical ailments, while longer wave infrared is beneficial for overall well-being and prevention.



Hot and Humid: Steam Room/Caldarium/Sudatorium

Steam Room/Caldarium/ Sudatorium

Temperature: between 40° C to 47° C

Humidity: up to 100%

The caldarium is the Roman precursor to the steam room (also known as steam bath). This was the hottest room in the ancient Roman baths—reaching up to 50° C and also had some of the highest humidity rates and air moisture saturation (i.e., steam). This room was heated by an underground furnace known as a “hypocaust,” essentially an under-floor heating system that piped hot water throughout the Roman baths. The fire source was typically located just below the caldarium, hence making it the hottest room in the baths, and, above the fire, a pool or cauldron of water resided and acted as the heat source for the room—delivering both heat and steam.

The modern steam room is unique in that it reaches 100% relative humidity—which gives it the element of steam/fog. It should be noted that in France, a steam room is called a “hamam”—this can cause some confusion as a traditional Turkish hamam or Moroccan hammam is not equivalent to a steam room (though smaller, private, hot rooms off the hamam have very similar attributes [see page 61]).

Due to the high moisture, steam rooms must be constructed of waterproof materials. One option is foam building boards with reinforced cement coating that will create a waterproof tank, prior to being finished with other water-resistant materials, such as porcelain tile, large custom ceramics, granite, or even acrylic. Thermal insulation provided by foam boards saves not only energy by reducing the working hours of steam generators and the amount of heating required, but it also reduces the maintenance costs of this equipment.

Unlike saunas, steam room benches are often on a single level because the temperatures are much more consistent throughout the cabin, but a two-tiered bench system can also be used. Continuous surfaces (stone or large-area heat storage ceramics) are a

great choice, but if opting for mosaic, be sure to use grout that is specifically designed to withstand heat and water.

Because of the constant steam, the interior of this room isn't often seen so it's worth considering function over aesthetics when choosing the materials in a steam room.

What makes steam rooms so compelling is the damp air they provide—when fine droplets of water come into contact with the air, they provide a negative, energizing charge. Bathers absorb these negatively charged oxygen ions, which can stimulate the metabolism, bringing about increased energy and even claims of fat burning or weight loss. To increase both relaxation and health benefits, aromatherapy is often added to modern steam rooms.

Type of Use

Deep relaxation, detoxification and general wellbeing are key reasons for the enduring popularity of steam rooms. Though not as hot as a sauna, steam rooms offer similar benefits at a less intense heat. In traditional Roman baths, this was the hottest area the bathers had access to and, similar to a sauna, should also be used in conjunction with cooling treatments—such as a cold plunge pool (frigidarium), ice room, snow room or shower.

Health Benefits

The intensive warmth causes the muscles to relax, and limb and joint pain is noticeably reduced. Steam rooms are often used to help those that suffer from rheumatism or arthritis. The high humidity also delivers positive moisturizing effects on the skin. As well, the alternation of heat and cold, using a cold plunge pool or snow room, ensures that a good supply of blood is pumped through the veins, helping to flush out toxins and regulate the blood.

Steam room at the Swissotel The Bosphorus, Istanbul, Turkey.



Courtesy: Kemitron GmbH

Common Steam Generator Types

Resistive Heat



Electrode



Heat Source

Steam Generator: A steam generator creates steam, which is introduced to the cabin by natural pressure caused by the expansion in the evaporating chamber; the steam travels through an insulated copper pipe and should enter the cabin silently via an open outlet. During the heat-up phase, steam is supplied to the still-cold steam room, increasing the relative humidity and the temperature. The room climate in a steam room is governed/controlled by the set-point temperature of the room, which is usually 42° C to 47° C. Once that temperature is reached, the steam production is interrupted until the room has cooled down by 2° C to 3° C. When the steam production is off, it is recommended the air extraction fan should be activated. This allows the steam generator to restart steam production quickly and helps keep a constant room humidity of 100%. It also provides visible steam in the room. If the humidity does not reach 95% to 100%, the steam won't be visible.

Steam production is governed by the room's temperature, and a re-ignition of steam is activated when the temperature falls below the desired value, so it's important to be aware that overheating the floors or benches can unbalance the steam generation.

The Principles of Immersion Heating

Heater elements are placed in a closed cylinder and connected to alternating current. The cylinder is filled with tap water, fully demineralized water or partially softened water. Heat generated by the heater elements increases water temperature to approximately 100° C. If fully demineralized water is used, the feed water is practically free of minerals. This ensures long life for the cylinder and heater elements since virtually no mineral deposits can settle or build up, ultimately, this should minimize the number of service/maintenance checks. If tap water is used, some of the minerals that dissolve in the water will settle in the cylinder as solids. These scale deposits are removed by periodic flushing or use of a heavy-duty blow-down pump. The generated steam has a temperature of about 100° C and minimal positive pressure ("pressure-less" steam). It is also virtually demineralized and germ-free.

Common Mistakes



- Overheating room with floor and wall heating—this will negatively affect humidity/steam
- Installing room temperature sensors in the wrong position, resulting in room not reaching 100% humidity
- Failing to install temperature sensors and other cabling within electrical conduits for ease of maintenance
- Steam outlets dangerously positioned, causing injury to bathers
- Not installing enough correct lighting/illumination; lighting needed to clean the unit is often forgotten
- Failing to install a way to flush/clean benches (a Kneipp Hose, for example)
- Use of wrong materials, such as gypsum boards or plywood, and/or wrong closing mechanisms
- Tiles poorly installed with incorrect grouting—so they easily pop off when exposed to heat and moisture
- Undersizing plant room and/or putting it in the wrong location (i.e., too far away)
- Incorrect ventilation and temperatures
- Using wrong slopes and drainage designs
- Failure to install water softeners in locations with hard water
- Incorrect installation of aroma injection into the steam pipe
- Ceilings too flat with no gradient, causing water to drip on guests
- Benches are often installed at an even level; however, this will result in an accumulation of water. Instead, a 2% decline is recommended to avoid water puddling

Steam generators are housed in a plant room. These can be designed into the structure or housed separately. It's important to get professional advice on the location and size of your plant room.

The two most common steam room generators are electrode, which pass electric current through a stainless steel element immersed in water, and resistive heat. Where possible, electrode- or resistive heat-type generators with cleanable and reusable cylinders are recommended. Their integrated drain pumps and flushing systems reduce lime scaling, and this leaves a smaller footprint combined with a more environmentally friendly operation. However, a key contributor to this decision is the type of water available on site, as a resistant-heat steam generator does not rely on water quality and can, therefore, be easily maintained. The water's conductivity depends on its inherent minerals and hardness or softness. Water quality must be tested to determine if an electrode steam generator or a resistive heat-type generator should be chosen.

Steam Inlets: The point at which the steam enters the room should be obvious to bathers and in a position that doesn't risk injury from either the hot steam or the nozzle itself. Steam inlets should not be located under benches or allow steam to enter the steam room under pressure. *Note: Refer to Chapter 8 for more detail on ventilation and climate control.*

Materials/Construction

Structure: One of the most efficient forms of constructing "wet" thermal rooms is using prefabricated, polystyrene panels that are cement-coated and reinforced with fiberglass on both sides. These panels are moisture- and mold-resistant, have high insulating values and are quickly and easily assembled on site. Other materials like acrylic or aluminum/glass can also be used.

Walls/Floors: Made of standard waterproof and mold-resistant materials; floor will have adequate drainage and slope for the water from Kneipp hoses, porcelain tile, granite, large-format, custom ceramics or even man-made surfaces.

Steam Room Components (Schematic Layout)

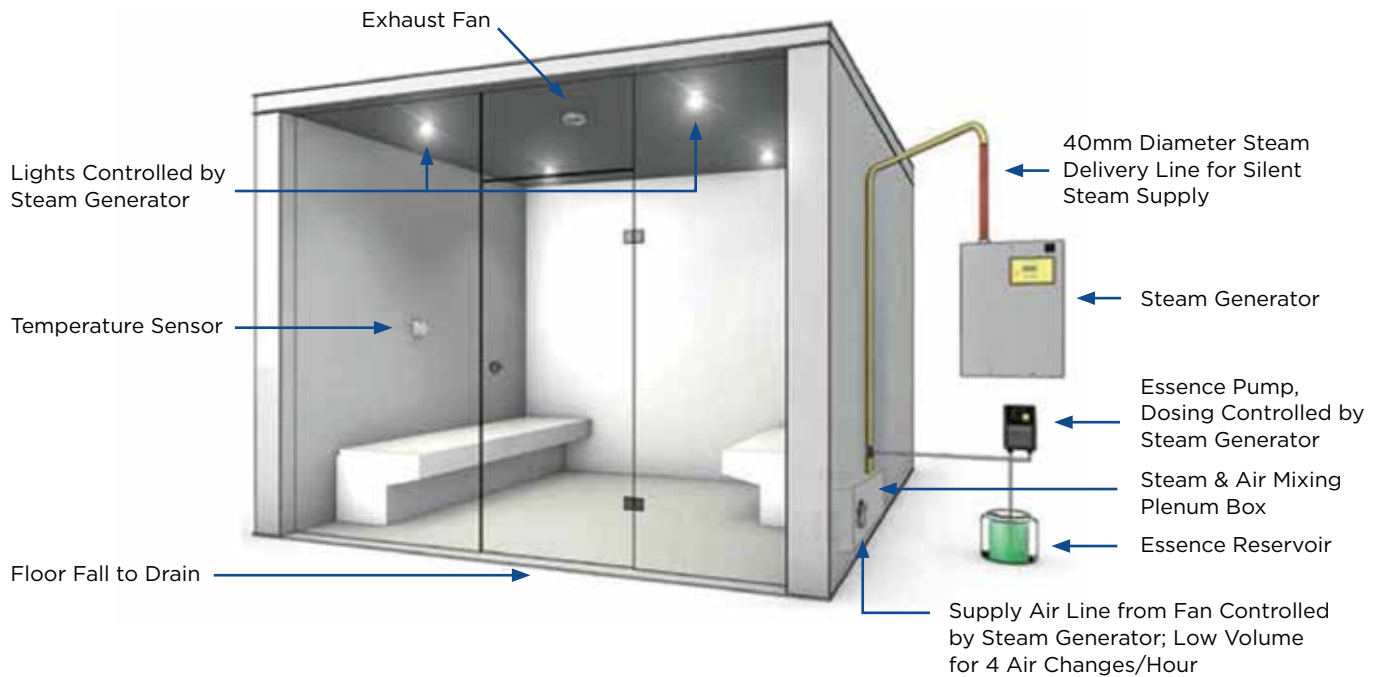

Benches: Ideally continuous stone or large-area heat storage ceramics; can be heated to body temperature from 36° C to 37° C.

Ceiling: Plastered and painted; steam- and etheric oil-resistant plaster; should not be higher than 200 mm above the head of the bather when sitting on highest bench.

Door: Tempered safety glass doors, clear glass to allow for un-obscured viewing. Handles should be stainless steel and doors should push open for easy exit. Doors should be retained, closed by a simple roller-catcher mechanism.

Design Considerations

Size/Space: Bathers like to lie down in a steam room so it should ideally accommodate a two-meter-long person. When designing steam rooms for commercial use, consideration should be given to personal space. The minimum amount you should allow for each person sitting down is 600 millimeters.

Benches: Continuous stone or large-area heat storage ceramics are recommended to minimize the number of joints on surfaces that bodies will come in contact with. This is beneficial for both comfort and hygiene.

Audio/Visual: Steam-proof speakers provided by a specialist wet-area manufacturer can be used. Consider color-changing lighting.

Illumination: LED spots in ceiling or under-bench lighting systems are recommended for visibility and durability, while fiber-optic lighting in the ceiling is sometimes used for mood enhancement.

Ventilation: Fresh air should be introduced with steam flow and it's crucial to maintain air quality through proper air exchange rates: for example, the Austrian ÖNORM M 6219 standard requires that steam room air is exchanged 6x each hour. An air outlet in the roof will remove warm air from the steam room to ensure continuous steam supply and a stable temperature control. Ideally, exhaust ducts should also be installed directly above the exterior of the

steam room doors to remove steam that escapes when opening and closing the door.

Special Considerations: Though it's not uncommon to use under-floor and bench heating, be aware that too much heat in the steam room will unsettle the temperature/steam balance. Nevertheless, the surfaces that bathers sit or lie on should ideally be set at an approximate surface temperature of $\sim 34^{\circ}\text{C}$ $\pm 2^{\circ}\text{C}$ (\sim body temperature).

Mineral deposits from the water can wreak havoc on the steam generator and other components, so look for easy-to-clean systems that seek to minimize these issues, and, instead of relying on tap water, think about using demineralized or soft water.

Consider installing a Kneipp hose for cooling off inside of the cabin. This feature will double as a hygienic way of rinsing benches before and after use.

How to Use a Steam Room

- Take a shower before entering the steam room—it helps with hygiene, plus, it's best to remove dirt and grime before sweating
- Remove clothing, jewelry and contact lenses
- Up to three sessions inside the steam room is recommended, each one slightly shorter than the previous
- Rest between sessions for 12 minutes to 20 minutes
- When finished let yourself gradually cool down; drink plenty of water
- Clean after use, rinse off space with water; a Kneipp hose is usually provided for this purpose



Courtesy: Design For Leisure Ltd.

The damp and humid air in a steam room can stimulate metabolism and increase energy, while moisturizing the skin.



Warm and Humid: Turkish Hamam/Moroccan Hammam

Turkish Hamam/Moroccan (N. African) Hammam

Temperature: between 38° C to 42° C

Humidity: 50% to 80% relative humidity

The Turkish Hamam Experience: Heat (not steam but humidity); followed by a full, vigorous body scrub (with a “kese” or rough mitt); water rinse; a soap massage and rinse; hair wash and rinse. Many modern versions follow that cycle with a full-body oil massage outside of the hamam.

The Moroccan Hammam

Experience: Heat/humidity; followed by a full-body, sticky, black soap massage and exfoliation with a “gome” glove; and then often a terracotta foot stone rub and rinse; a clay/mud application to body, face and hair (and rinse or soak). Also often followed by argan oil application.

The word “hamam” literally translates as “bathroom” in Turkish and refers to the entire Turkish bathhouse. There are two principle styles of hamams—the Turkish hamam and Moroccan or North African hammam. Both derived from the original Roman bathhouses (built after the Romans conquered the respective regions). Upon the Romans’ departure, the Turks and North Africans evolved their hamams/hammams to better suit their cultural needs—including the fastidious cleansing of the body (and soul) as a component of the Muslim faith. A strong byproduct of this communal bathing was the socializing element. A Turkish hamam is a large domed structure with a central room (sikaklek) in which the belly stone (göbek tasi) takes center stage. The belly stone is traditionally where attendants scrub and clean bathers, and there are often small rooms off the large central space that were used for wealthier customers to be washed in private—these design concepts are frequently used in modern hamams for private treatments. There are a large number of basins (called kurnas) around the room that supply water for washing and rinsing,



“Hamam” translates as “bathroom” in Turkish and refers to the entire Turkish bathhouse. Hamams were derived from the original Roman bathhouses.

Common Mistakes



- Confusing a hamam with a steam room—these are different experiences and different room types
- Improper building materials causing issues with cleaning and maintenance
- Forgetting or not providing enough space for plant room
- Poor drainage, causing water to pool on floors
- Not installing temperature and humidity sensors in easily accessed, maintainable conduits
- Placing steam outlet in positions where bathers get injured by the hot steam
- Not installing enough lighting/illumination—often forgotten is the lighting required to clean the unit
- Failing to install a way to flush/clean benches (e.g., a Kneipp hose)

and plenty of bench space where bathers can wait for treatments or relax and socialize.

A Moroccan hammam is similar to its Turkish relation but has retained more of the traditional Roman bathing ritual—sending the bather on a journey through smaller chambers with varying temperatures (like the Roman journey through the laconium, caldarium, frigidarium and tepidarium).

Note that “hamam” is sometimes confusingly used as a generic term to describe a steam bath or a steam room. This is particularly common in France and the French-speaking territories of Switzerland. For clarity, this reference book refers to the hamam as a bathing structure (including communal and treatment areas).

Type of Use

Cleansing was the original purpose of the hamam—and today hygiene still plays a central role. Typical treatments include an exfoliating rub with a “kese” (Turkish) or “gome” (North African) mitten, a soap massage (black soap in North Africa) and hair wash. In addition, socializing and relaxation are the key goals of most bathers.

Health Benefits

The hot air temperature and warmth of the treatment surface (whether a traditional belly stone or a modern heated treatment table) relieve muscle pain and promote mental relaxation, while the high humidity produces intense sweating, which leads to a detoxifying cleansing.

Heat Source

Traditionally, a hypocaust provided warm under-floor heating, replaced by hot water “hydronic” systems as piped plumbing systems were developed. Often the floors were heated higher than body temperature, requiring bathers to wear wooden sandals (which became serious fashion statements in the heyday of Turkish hamams). A modern hamam will use hydronic heating, a system of pipes heating the floor, walls and benches to maintain a high radiated temperature.

Unlike a steam room, the hamam does not operate at close to 100% humidity. A high level of humidity (50% to 80%) is required, however, and this was traditionally generated by the large amount of water being used in the treatments and evaporating off the hot floors and seating/treatment surfaces. Today’s guests aren’t always comfortable with the public bathing rituals so massage, exfoliation, shaving and hair washing may be undertaken in private rooms. This means humidity levels often need to be augmented in other ways—either through a steam generator or water-misting system with appropriate venting and air circulation systems.

These are connected to humidity and temperature sensors, allowing for accurate control of the hamam environment.

In ancient Roman bathhouses, a hypocaust system was used to heat the rooms—similar to today’s hydronic systems.

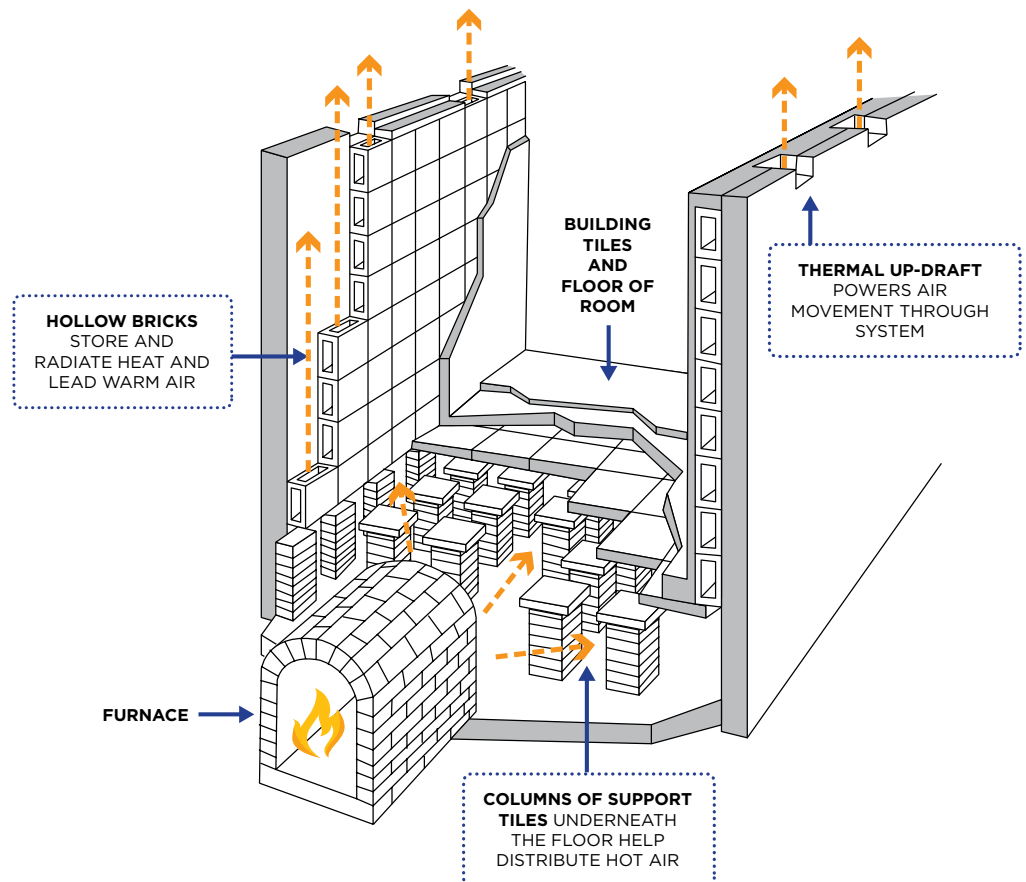

Materials/Construction

Structure: One of the most efficient forms of constructing “wet” thermal rooms is using prefabricated, polystyrene panels that are cement-coated and reinforced with fiberglass on both sides. These panels are moisture- and mold-resistant, have high insulating values and are quickly and easily assembled on site.

Walls: Porcelain tile, large-area heat storage ceramics, marble, granite, or even man-made surfaces like Avonite, Silestone and other agglomerates.

Floors: Prefabricated tileable floors with integrated gradient and warranted waterproofing. Stone tiling with integral drains set into the floor to avoid pooling of water and to aid cleaning and maintenance. Slip-resistant surfaces are essential (following the German DIN 5109-7 standards for barefoot traffic, classification B, is ideal).

Benches/Göbek Tasi: Finished using continuous stone surfaces (or similar man-made surfaces); if opting for a special pattern or design, use grout that is resistant to water and heat. Note the göbek tasi is often still present, usually as an acknowledgment to tradition rather than a dedicated treatment surface, but keeping this traditional “amphitheatre” style is popular and provides a large surface for lying down.

Ceiling: Plastered and painted, steam- and etheric oil-resistant plaster. May be tiled/include ornamentation for aesthetic considerations.

Lighting: Traditional hamams have piercings in the domed roof, sometimes in quite intricate shapes, allowing sunlight to shaft through these “elephant eyes,” which often have diameters of 10 cm to 15 cm. Modern lighting technology can be used to replicate these ideas, from simple, round downlights to complex systems where lighting projectors shine through to replicate the shafts of sunlight in traditional settings.



Faena Hotel, Miami Beach, Photo: Nik Koenig

Private scrub room
at Faena Hotel,
Miami Beach.

In a traditional hamam, there are a large number of basins (called kurnas) around the room for washing and rinsing, and plenty of bench space where bathers can wait for treatments or relax and socialize.



Courtesy: Barr + Wray Ltd.

Design Considerations

Size/Space: The ceiling should be designed to include a traditional domed cupola roof or vaulted ceiling. It may be appropriate for heat recovery systems to be installed to re-circulate the heat at higher levels.

Aromatherapy: Automatic essential oil dosing system.

Audio/Visual: Low-level audio with water/steam proof speakers.

Illumination: Soft, indirect lighting from LED and fiber optic.

Ventilation: Fresh air supply and air extraction will ensure good oxygen levels. The recommended air turnover is 4-7 changes per hour, with an incoming air temperature between 18-24 degrees.

Special Considerations: An authentic atmosphere is achieved when the room is finished in traditional Turkish “Iznik”-style tiles and Carrara Blanco marble; while North African hammams favor a traditional plaster finish called “tadelakt,” which isn’t advised in commercial applications. Although there are some

excellent modern plasters that can achieve the same effect, dramatic designs have been created in modern hamams using less traditional types of natural stone and tile.

How to Use a Traditional Hamam/Hammam

- Take a shower before entering hamam/hammam
- In a public bath, you will be given a “pestamal” (a towel with fringed ends)
- Enter the dry, warm room to start the bathing process
- When moving to the hot room, women usually remove their towels, while men traditionally keep theirs on. Women and men bathe separately.
- Use the basins (“kurnas”) to cool down with cool water while in the hot room
- Await cleansing rituals, including exfoliation, hair washing, shaving, etc. (Foam plays a large role in these rituals. The foam can be created by a hamam/hammam master or automated for self service)
- This can be followed by a private massage



Warm and Dry: Laconium; Tepidarium/Warm Relaxation

Laconium

Temperature: between 38° C to 45° C

Surface temperatures: approximately
34° C +/- 2° C

Humidity: between 10% to 20%

Tepidarium/Warm Relaxation Room

Temperature: between 30° C to 40° C

Surface temperatures: approximately
34° C +/- 2° C

Humidity: between 20% to 40%
(not controlled)

Laconium

The laconium is a relaxing, dry heat environment with a temperature below the aggressive levels of a Finnish sauna. In Roman times, it was seen as the dry, sweating room of the *thermae*, adjacent to the *caldarium* steam room with its higher temperature. It provides a more relaxing, less-intense experience allowing for a longer treatment—usually 20 minutes but up to an hour. It is recommended for individuals that find the dry 80° C to 105° C heat of the sauna too hot and the 100% humidity of the steam room too high.

The laconium plays an important role in many spas for guests who have contra-indications (such as pregnancy or cardiovascular conditions) that prevent them from using the hotter rooms. Offering this option makes the spa more inclusive.

Type of Use

At a temperature of 38° C to 45° C and relatively low humidity, the laconium environment is relaxing. Sitting or lying on warm/hot benches and loungers warms the body quickly and helps start the sweating

process. Cold-water Kneipp hoses are available to wash away perspiration, creating a hot-cold purification and detoxification cycle.

Health Benefits

The purpose of the laconium is to purify and detoxify the body by stimulating circulation. The heat-based treatment improves blood flow, increases metabolism, promotes mental and physical relaxation and reduces stress. Applying essential oils such as lavender, eucalyptus and citrus to the skin can also enhance the positive effects of the heat—promoting mind-and-body re-generation. Aromatherapy oils are often used in the laconium for the same purpose.

Heat Source

The heat is radiated evenly from the walls, floor and reclining surfaces. In Roman times, this was provided by under-floor hot air in the hypocaust. In modern times, the dry heat is generated by electrical elements or piped hydronic hot water systems within the walls, floors and benches themselves. The surface temperature of the seats is around 30° C to 35° C, the floors 40° C to 45° C and the walls 60° C to 70° C.

Materials/Construction

Structure: Generally ample in size, with enough room to seat six to 16 people. The interior is usually tiled to provide both the radiated heat surface and a pleasing aesthetic.

Walls/Floors: Made of standard waterproof and mold-resistant materials; floor will have adequate drainage and slope for the water from Kneipp hoses. Prefabricated, tileable shower bases with integrated gradient and sealing are an option.

Benches: Ideally continuous stone, heat-storing ceramics or other waterproof material to minimize/avoid grouting. Almost always static and fixed to the floor to allow for heating element to be connected; temperature is between 30° C to 35° C.

Ceilings: Can be tiled for effect, but, otherwise, coated in waterproof paint.

Door: A self-closing door is required to retain the heat in the room.

Heated, body form loungers are ideal in relaxation rooms.



Courtesy: Barr + Wray Ltd.



Tepidariums were traditionally used to warm up before entering warmer rooms, but they are now most often used to cool down after a sauna or steam bath.

Design Considerations

Walls/Benches/Floors: As the laconium is a steam-free environment that bathers remain in for extended periods of time; the interior usually reflects a luxury environment and is often opulent in its tiling and fittings.

Audio/Visual: Low-level and ceiling lighting, together with discreet music, can enhance the relaxing atmosphere. Placement of equipment requires careful consideration; equipment must be accessible for maintenance.

Special Considerations: The room needs regular cleaning to ensure acceptable hygiene standards so drainage system should take this into account. Guests may be using this space to relax after the intense heat of a steam room or sauna so chilled refreshments are

often offered in this space, even if it is only a chilled water fountain.

How to Use the Laconium

- The laconium can be a specific heat-based relaxation treatment, and it can also be part of a spa cycle preparing the body for more extreme temperatures
- Wear a towel to protect the skin from the hot reclining surfaces, as well as for hygienic reasons
- Sit or lay for periods long enough to allow perspiration from the body
- Use Kneipp hoses to wash off sweat and encourage blood circulation, particularly to the extremities
- Repeat the cycle

Tepidarium/Warm Relaxation Room

In ancient Roman baths, the tepidarium had a central role as a relaxation and body care room. Typically the air temperature would be warm (tepidus), around 30° C to 40° C with constant radiant heat, at a higher temperature, coming from the stone walls, floors, bench seating and individual recliners.

The tepidarium was often the central hub of a Roman bath, linked to other hot and cold rooms. Bathers would use the tepidarium as a focal point for warming up the body, engaging in body treatments (oils and cleaning), as well as relaxation. In a modern spa, this area is usually referred to as the “relaxation room” and will often have individual stone/tile recliners and bench seating with thermostatically controlled electric or hydronic heating. Of course, many “relaxation rooms” today feature normal beds or cushioned loungers, but they often have an element of warmth to them and their concept has derived from the traditional tepidarium.

Type of Use

The tepidarium is traditionally used to warm up the body before using other baths, as well as to recharge body energy through heat from the benches, floor, walls and fixtures. It can, of course, be used for gently cooling down following periods in a sauna or steam room, or indeed warming up after using a plunge pool, cold shower, ice room or snow room. It provides a counterpart to other hot and cold treatments and is also a key relaxation area in the modern spa.

Health Benefits

The radiant heat offers deep tissue/muscle penetration to soothe and relax individuals.

Heat Source

In a modern spa, air temperature is controlled by the central heating system (warm air ducts) with electric or hydronic under-floor heating. An under-floor heating system adds considerable flexibility to the heat source, and, although initially more expensive to install, has cost efficiencies over a longer term.

An alternative to heated, body forming loungers are soft, warm beds—water beds offer a nice alternative to traditional mattresses.



Common Mistakes



- Room lacks the privacy guests desire or is not big enough or too bright for relaxation
- Choice of loungers uncomfortable—too small, too hard, not ergonomically shaped
- Use of incorrect building materials
- Allowing noise from plant rooms or other treatment rooms to infiltrate relaxation area
- Incorrect ventilation and temperature
- Aromatherapy is often overlooked because there is no carrier (like steam or water), however, aroma systems that use evaporation can be used in Tepidariums
- Guests can consider these rooms “boring”, consider adding a small fountain or aromatherapy fog fountain to encourage guests to spend enough time relaxing

Benches and recliners have additional hydronic or electrical heating to increase the radiated heat/infrared heat level. The benches and recliners are often fixed (non-moveable) fittings.

Materials/Construction

Structure: Generally ample in size, with enough room to seat six to 16 people. The interior is usually tiled to provide both the radiated heat surface and a pleasing aesthetic.

Walls/Floor: Usually of ceramic tile/stone to maximize the radiated heat, and, like the laconium, are often more ornate because they are dry, and bathers spend a great deal of time in them.

Benches/Loungers: Also of stone and tile for the same radiated-heat benefit. Loungers are contoured to allow for comfortable relaxation with individual thermostats to control radiated-heat temperature. Loungers are often two-piece—a base pedestal and a horizontal reclining surface, often tiled with mosaic

to enhance the aesthetic appeal of the room. Other surfaces include stone and ceramic, which minimize joints—improving comfort and facilitating cleaning.

Ceilings: Can be tiled for effect, but, otherwise, coated in waterproof paint.

Door: A self-closing door is required to retain the heat in the room.

Design Considerations

Size/Space: The overall size is generally dependent on the other bathing facilities/overall capacity of the spa. Individual loungers need to encourage relaxation usage and should be approximately 700 mm x 2,000 mm x 900 mm (w x l x h).

Audio/Visual: Low-level and ceiling lighting, together with discreet music, can enhance the relaxing atmosphere. Care needs to be taken with placement of equipment which needs to be accessible for maintenance. Tepidarium does not have extreme heat/cold or specific water applications so the construction does not necessarily have to be as robust as other bathing areas.

Surfaces and fittings should be waterproof, and electrical elements must be sealed and protected (with circuit protection/circuit breaker capability) to allow for cleaning and maintenance. As the Tepidarium is a relaxation area, a key focus is the design aesthetics, including audio and lighting. The provision of privacy areas using screens and curtains is common.

How to Use a Tepidarium

- Use this area to acclimatize to higher temperatures prior to using other bathing rooms
- Always use a towel to recline on
- Relax in the room, following hot/cold and water/dry treatments
- Use individual audio/other sensory facilities (if provided) to enhance relaxation and feeling of wellbeing



Warm/Cold and Wet: Experience Showers; Foot Bath/Kneipp Walk

Experience Showers

Warm and cold waters have always been integral to the thermal bathing ritual—allowing the body to cool down—and are key elements of the traditional tepidarium and frigidarium. A more modern interpretation is using a standard shower for a quick cool down after a sauna or steam room.

In recent years, this has evolved into the “experience shower”—a combination of water, sound and smell that evokes a natural “event” for the bather, with themes ranging from “emotional showers” and “energy showers” to “waterfall/deluge showers” and “monsoon showers” to many in between.

Type of Use

An essential part of thermal bathing is cooling the body down—this is important for enjoying spa facilities safely and maximizing health benefits. The experience shower goes further than a simple shower by adding an entertainment element to the everyday activity of showering.

Typically, the experience shower combines water flow variations, sounds and music, dynamic lighting and

even aromatherapy to deliver a multi-sensory stimulus. The key element in the showers is the water jets that can be programmed to deliver different experiences. Strong, lateral jets facilitate massage, overhead water buckets deliver a dump of cold water, and water mists gently hydrate, while temperature-contrast showers deliver water. Jets can also be programmed to mimic nature; for instance, rain, thunderstorm, mist and waterfall. A handheld showerhead is often included for washing prior to a sauna or steam treatment, as well as for providing additional cooling. Some common Experience Shower themes include Rain Forest, Tropical Rain, Cold Waterfall, Polar Mist, Monsoon, Summer Storm, etc. An individual shower enclosure often has several pre-programmed themes that last between 30 seconds to three minutes.

A new trend gaining in popularity are rain walk or tunnel. This gives users a unique, active experience because the bather is lead through the tunnel/walk through automated programs that lead him/her from zone to zone. The programs are either activated by a push button or photo sensors at the start of the walk/tunnel.



Both images courtesy of WDT Werner Dosiertechnik.



Experience showers combine water, sound and smell to evoke a natural “event” for a bather.

Health Benefits

Body cooling after heat treatments ensures a good supply of blood to the skin and internal organs, helps to flush out toxins and closes skin pores. The multi-sensory experience-shower approach also adds stimulation of the senses—driving other emotional responses, ranging from excitement to contentment. This offers a unique, new element to the overall wellness benefits.

Heat/Cold Source

Hot and cold water are piped to the showerheads with a looped supply to provide the bather with instantaneous hot or cold water on demand. Sufficient water pressure/capacity is essential to maintain the multi-head shower flows.

Materials/Construction

Structure: Size and shape (square, round, snail, etc.) depends on the site layout. Specially designed, prefabricated, polystyrene panels that are cement-coated and reinforced with fiberglass on both sides, should be moisture-resistant and waterproof.

Walls/Floors: Usually tiled; drainage capacity/floor slope is a key element of a successful design. Prefabricated, tileable shower bases with integrated gradient and sealing are a good option.

Design Considerations

Size/Space: Enclosures are typically for a single person. Size is approximately 140 cm x 140 cm x 250 cm if square and 120 cm in diameter if round. However, a rule of thumb is to never create a shower smaller than 100 cm x 100 cm x 250 cm or larger than 200 cm x 200 cm x 250 cm. Height can vary between 220 cm to 300 cm. As experience showers don't usually have doors, be aware that a fine mist spray can travel out of the enclosure into surrounding areas.

Audio/Visual: Music and sounds are generated by an integrated MP3 player with memory card and activated through the control panel. Common sounds include tropical rain, thunder, waterfall, birdsong, waves/sea, river/stream, etc. A water-resistant, mounted speaker(s) on the ceiling provides the audio. LED lighting provides visual cues to support the experience—dark skies, sunset, sunrise, etc., and smells like fruit,

flowers, spices, and sea, can be added to enhance the experience.

Aromatherapy: A dosing system linked to the control panel provides the fragrance. This level of technology requires adequate space for placement and easy access for maintenance, as well as robust waterproofing. In addition, it's imperative to ensure that the aroma does not flow back into the local water supply.

Special Considerations: Positioning is usually in proximity to heat treatment rooms. Additional features, such as simulated wind/breeze, can also be added, requiring additional ventilation.

An experience shower consists of a lot of components in a relatively small structure, so placement, access and waterproofing are key aspects of a successful installation—as is the overall management of water quality, pressure and drainage.

In order to cut corners or save money, some facilities opt for a “standard” shower, but standing under a cool/cold shower for 30 seconds to 180 seconds, the ideal time required to start the cooling process, can be very uninspiring. The features offered by Experience Showers are designed to hold the bather's interest and act as a distraction; consequently, there is a greater chance of the bather getting the full cooling treatment and deriving maximum benefit.

How to Use an Experience Shower

- Pre-programmed experiences are selected from a push-button control panel
- The user stands in the water jet area as the program runs
- Different programs can be experienced
- Handheld showers/Kneipp hoses can be used for individual cleaning/cooling requirements

The controller, dosing pump and other equipment used to run an experience shower.



Common Mistakes

- Not having enough water pressure to make shower experience operate correctly
- Water quality—hard or dirty water can damage equipment, increase maintenance frequency and create a bad guest experience
- Improper sealing of electrical and hydraulic equipment within shower
- Improper sealing of push buttons against the tile often leads to damaged buttons
- Incorrect calculation of draining slope and draining capacity
- Shower cabinets can be too big, causing an unpleasant shower experience
- Plant room forgotten or too far from showers
- Badly executed aroma dosing. New regulations in Europe insist that a non-return device is installed to avoid the aroma getting sucked back into the main water supply—which could be dangerous to guests.
- General overuse of aromas





Foot baths are recommended to use in conjunction with heat experiences.

Foot Baths

Foot baths are a major part of European spa and wellness culture. Taking alternating hot and cold water foot baths has been proven to reduce stress levels. Foot baths are also said to improve the cardiovascular system and are recommended to use in conjunction with a sauna.

Foot baths allow for alternatively enjoying warm or cold foot baths. At the press of a button, a basin can be filled with either warm or cold water. Once the water level is reached, most foot spas automatically stop filling and begin blowing air into the basin to stimulate the foot reflex zones. The bubbling starts automatically for a programmable time. Once it goes through this cycle, the bather's feet can remain in the water a little while longer and then the basin will be automatically emptied.

Once a cycle is completed, the whole system is disinfected—including drain piping, air piping and the basin—making it totally hygienic for use by several people one after the other

An alternative to foot baths is the Kneipp Walk (outlined in Chapter 6).



Courtesy: WDT Werner Dosiertechnik



Cold: Plunge Pool/Frigidarium; Snow Room; Snow Shower/Snowfall

Plunge Pool/Frigidarium

Temperature: 5° C to 20° C

Humidity: Not controlled

Snow Room

Temperature: -15° C to 0° C

Humidity: Not controlled

Snow Shower/Snowfall

Temperature: 0° C to 40° C
(4° C - 18° C recommended)

Humidity: Not controlled

Cold immersion is an age-old tradition in hydrothermal bathing. The Finns are among the first known to actively use hot and cold contrast therapy as part of their cleansing ritual. After spending time in a hot sauna, bathers would leave the cabin, sweating profusely, for a “roll in the snow” that not only cooled them down but also cleansed the dirt from their bodies.

The tradition may have evolved out of a basic need to cool down and get clean, but the Finns also enjoyed the invigorating properties of hot and cold contrast therapy which has been shown to promote heart health, detoxification and even reduce blood pressure.

Just as the Roman baths had variations on the frigidarium, including plunge baths, cold-water pours and cold swimming pools, the modern interpretation also includes snow and ice treatments to maximize the “chill” concept. And, as more bathers embrace the power of cold (cryotherapy) to aid in recovery and overall wellbeing, these experiences have steadily grown more popular.



The freezing temperatures of plunge pools speed up the cooling down process, while closing the skin pores and helping the body flush toxins.

Plunge Pool/Frigidarium

The traditional frigidarium is a large cold-water pool, typically entered after the hot caldarium (steam room), warm laconium and tepidarium (relaxation). It was considered a key part of the *thermae* journey and served to cool down bathers between hot treatments, as well as close the pores of the skin after exposure to heat before leaving the baths. The cold water traditionally came from mountain streams, cold springs or underground cisterns.

Type of Use

The plunge pool/frigidarium can be a starting point in a spa bathing experience, or, more commonly, used as a cool-down element within the spa bathing cycle.

Health Benefits

After exposure to a hot environment, the body typically experiences a physiological slowdown, entering a semi-inertia state. The surface capillaries of the skin are dilated, blood pressure is lowered, the skin has a high color and there is a general deprivation of blood to internal organs. These conditions, plus external sweating, persist while the body cools down. The temperature of a frigidarium speeds up the cool-down process.

The cooling-down process accelerates the supply of blood to the skin and internal organs, facilitates toxin flush out and closes the skin pores to prevent dehydration.

The vascular dilation provided by the heat and rapid contraction from the cold enables the slowed-down, cooled blood to act as a “pipe cleaner” for the restricting fine-membrane arteries.

Cold Source

A cold plunge or frigidarium pool commonly uses standard cold water that is filtered and treated the same way as any public bathing pool and chilled down. Heat exchangers are used to maintain cool temperatures (in busy spas, frequent use will heat the water up).

Construction

Frigidariums come in all shapes and sizes and can include everything from cold-water swimming pools to small-diameter plunge pools. However, a minimum depth of 1.5 m is required. For more details on pool construction, see Chapter 6 on *Pool Areas: Function and Design*.

Special Considerations: A frigidarium should be located in close vicinity to heat treatments so they can be integrated into the bathing rituals. When installing

a plunge pool, be sure to install a shower nearby for bathers to rinse off before entering—this will vastly improve the cleanliness of the pool water, reducing pressure on the filtration system and ultimately reducing water loss through less-frequent need for backwashing the filters.

Snow Room

The snow room is a modern alternative and considered a gentler option to the “shock” that comes from plunging into icy waters after a hot sauna or steam room. Advances in refrigeration technology mean that it’s now possible to replicate the traditional Nordic “roll in the snow” in any hydrothermal facility.

Snow rooms offer another benefit: snow simply makes people happy, bringing out their playful, inner child. Cold crisp air combined with having real snow within grasp makes it a one-of-a-kind experience.

Type of Use

The sub-zero temperatures and snow are a welcome respite to the heat of various other treatments. The cold air within the snow room refreshes lungs and airways. Fresh snow is then used to cool down specific areas of the body and underscore the refreshing effect. Snow rooms are usually placed near the warmer cabins, allowing bathers to enjoy the health and recreational benefits of the cold.

Cold Source

A snow room consists of an insulated room and a separate snowmaking system located in a plant/mechanical room. Cold air and water are provided by the snowmaking system, which is cooled either by a chiller condensing unit or by another cooling system available in the building.

How Is the Snow Made?

Snow is made by simulating the natural formation of snow. The difference is that it’s accelerated using special indoor snowmaking technologies. The modern technologies on the market work with a closed air refrigeration circuit system and a nozzle system spraying water and compressed air into the snow room. Only the natural elements of drinking water and air are used for the snowmaking process—no chemicals or biological additives are necessary. Snowmaking is usually carried out at night so that guests can enjoy fresh snow the following morning.



Today's snowmaking technology produces the equivalent of natural snow with just air and water - there are no added chemicals. Snowmaking is carried out at night so guests can enjoy fresh snow the following morning.

Health Benefits

The near-freezing atmosphere of a snow room provides the same health benefits as a plunge pool does with the added benefit: inhaling cold air creates vascular dilation in the lungs, an area that is very difficult to reach any other way. In colder climates, during evenings and autumn/winter, this cold-air benefit can also be provided with access to outside spaces.

Materials/Construction

Structure: One of the most efficient ways of constructing "wet" thermal rooms is using prefabricated, polystyrene panels that are cement-coated and reinforced with fiberglass on both sides.

These panels are moisture- and mold-resistant, have high insulating values and are quickly and easily assembled on site. Another option for cold rooms are 10-cm metal sandwich plates, powder-coated outside.

Walls: These reflect overall design requirements. Mosaic and other small-format tiling is not recommended as the drastic temperature changes within the room can damage the grout over time. Decorative elements that are temperature stable are ideal. A good rule of thumb to follow is to use materials found in outdoor construction or decoration, like glass-fiber reinforced plastic or glass.

Floors: The floors should have adequate drainage, and be completely waterproof at all joins. Tiles should have the highest anti-slip rating possible.

Benches: Are suggested so that guests can enjoy their stay in the room for the recommended timeline.

Ceiling: Textured/non-drip render complemented by design requirements (tile, etc.).



Courtesy: TechnoAlpin S.p.A.

Snow offers a welcome respite from the heat of the warmer rooms/cabins in a hydrothermal area.



Courtesy: TechnoAlpin S.p.A.

Design Considerations

When designing a snow room, it's important to remember that the snow is the feature of the room and abundant amounts of snow should be made accessible to guests. So it's important to include ledges or other decorative elements where snow can fall and rest.

Size/Space: Snow rooms range in size from approximately 4 to 16m² (up to 20m²). The snowmaking system is either a separate or partly integrated system that works together with the snow room to ensure the correct temperature and snow production. Various variations of the system are available. All systems combine refrigeration technology with snow making technology. The snowmaking system is located in a plant/technical room and requires additional space (the minimum required is approximately 5m²).



Common Mistakes

- Using incorrect building materials; lacking the insulation needed to keep room cool
- Cooling with too much air flow or incorrect cooling systems
- Plunge pools often designed with ineffective ways to enter and exit—stairs too high or no railing
- Failing to create a buffer zone between traditional heat therapies and cold treatment rooms

Snow is considered a gentle, playful alternative to the more traditional frigidarium.

Ventilation: The room should be completely insulated, not ventilated. In case of ventilation, the incoming air would have to be sub-zero and dry, that would require additional air conditioning.

Special Considerations: The snow room should be located in close vicinity of heat treatments so that they are integrated into the bathing rituals. Due to the very cold temperatures within the room and the heat penetration from the spa area each time the door is opened, it is highly recommended that a buffer zone be created. The buffer zone should be an area of approximately 2m² and temperature controlled. This is also more energy efficient as it reduces the cooling necessity of the snow system. The buffer zone can be optimally integrated into the wellness area and is highly suggested especially for areas with high footfall. It is not as vital in private spa settings.

Snow Shower/Snowfall

The sensation of melting snow on the skin is another alternative for bathers looking to cool down after a hot cycle. Snow showers deliver a gentle alternative to traditional equipment and experiences like Kneipp hoses, plunge pools, waterfall showers or crushed ice treatments. Snow showers are either open or closed areas where a continuous snowfall can be generated by pushing a button.

Types of Use

This is snow on demand—the bather activates the shower and snowfall begins in approximately 10 to 30 seconds and, depending on personal preference, the shower will last between two to five minutes. Advanced snowfall production technologies produce natural real snow in ambient temperatures ranging between 0° to 40° C.



Courtesy: SnowBOX

Health Benefits

Cooling down the body with a snow shower after exposing it to high temperatures is a gentle alternative to a plunge pool and the sensation of snow melting on the skin has the added benefit of being fun and delightful—providing another positive experience for the bather.

Cold Source

When using snowfall snow-making technology, there is no need to cool down the area using a separate cooling system. This new technology means it's possible to use snowfall technology in other experiences, such as snow rooms, snow plays and snow fountains, at temperatures up to 40° C. The snow is simply produced from water and electricity—no chemical additives are used in this process. A refrigeration generator and a heat exchanger are used to cool the water down, and then freeze it to create nice, light snowflakes. Snow showers can be used in ambient temperatures of up to 40° C.

Materials/Construction

Snow showers can be integrated in almost any space within a hydrothermal area. Built as either a single unit with equipment mounted on top or as a split unit with the cooling technology residing in an adjacent plant/mechanical room. The latter solution keeps any noise from the snow making away from the guest area.

Design Considerations

There are minimal restrictions regarding the design of snow shower areas: they can be designed as an open space or feature walls made of glass, natural stone or tiles. Sound or light effects can also be integrated.

Having real snow falling on a bather is a unique and fun way to gain the benefits of hot/cold therapy.

Contrast Therapy: The Dr. Thuile Method

Dr. Christian Thuile, Medical Director of the Department of Complementary Medicine at the Merano Hospital in South Tyrol, Italy and author of *Schneesauna – Die Wellness-Revolution (Snow Sauna – The Wellness Revolution)*, has developed a guide on how to most effectively use snow rooms in conjunction with saunas.

The method is based on a number of scientific studies that have assessed bodily reactions to the effects of the cold. The conclusion is that, when used correctly, the hot and cold contrast can lead to a number of health benefits, including reducing fatigue, improving rheumatoid arthritis, pain reduction as well as minimizing muscle soreness after activity and improved regeneration after intense training.

The Dr. Thuile Method is based on the alternating between a heat source, such as a sauna, and a snow room (-10° C to 0° C). By following the Dr. Thuile Method, blood vessels extend and contract quickly resulting in improved blood circulation in the entire body. Furthermore, more oxygen and nutrients are transported to cells, strengthening them and benefiting the heart and circulatory system.

After spending time in a hot sauna, the body is fully warmed and muscles are more mobile and relaxed, cramps are loosened, connective tissues are more elastic and pores are opened. Many people experience exertion and fatigue after a sauna experience. Cooling the body down and bringing it back to its natural temperature as soon as possible is a necessary step.

The cold of a snow room is often perceived to be less invasive than a cold or wet option (frigidarium), allowing bathers to spend more time in the area, thereby maximizing the effects. When in the snow room, it is highly recommended that one use the powdery snow to additionally cool the extremities of the body, such as legs and arms. The very cold snow reaches temperatures below 0° C and the process of rubbing the snow onto arms and legs assists cooling

in those areas. The positive side effect is that one can avoid the intensified cooling on other more sensitive areas of the body. The cold can be specifically applied to assist in reducing inflammation and joint soreness as well.

Immediately after entering a snow room, the body begins to react to the cold, causing vascular constriction or vasoconstriction—a narrowing of the blood vessels—and, in the cold ambiance, the blood flow centralizes to protect vital organs.

The contrasting vasodilation—expansion of the blood vessels—that occurs in the heat of sauna, followed by the vasoconstriction causes increased blood flow to the skin, muscles and tissue. According to Dr. Thuile, this can be particularly beneficial for people with low blood pressure, especially if repeated on a regular basis.

Of over 200 people studied using a snow room in combination with a Finnish sauna, subjects reported improved sleep, significant pain reduction, better moods and an increased amount of energy, relief from stress and pressure, improved breathing, softer skin and a healthier sense of self.

How to Use a Hot/Cold Therapy

- Settle in for three to four minutes; acclimatize to the hydrothermal environment. Loosen up muscles by walking or stretching.
- Warm up for 12 to 15 minutes; dry sauna.
- 80° C to 100° C. Stay as long as comfortable.
- Cool down (three to five minutes for women; four to eight minutes for men) in a snow room at temperatures up to -10° C. Sit or stand in the snow room. Take deep breaths of the fresh air. Rub snow on arms and legs to intensify the effect.
- Relax for 15 to 20 minutes in ambient temperature; sit or lie down and ensure sufficient liquid intake.



Specialist Hydrothermal Treatments & Therapies

.....

This chapter takes a closer look at the various specialist hydrothermal treatments and therapies found in wellness centers and spas to help readers understand their functions and benefits, and provides guidance on the design and configuration of these rooms.

.....

In addition to communal hydrothermal areas, many wellness centers offer specialist cabins/rooms for specific hydrotherapy treatments, including inhalation therapy like salt, oxygen or aromatherapy and mud bath rituals, body wraps and scrubs. Additionally, specialist hydrotherapy equipment, like Vichy showers, hydrotherapy tubs, and Kneipp hoses can be offered as stand-alone experiences or add-ons to other bodywork.

Another common trend is to offer guests access to private spa suites that feature miniature hydrothermal experiences—usually some combination of a sauna, hamam or steam room—so they can enjoy the positive effects of thermal bathing at their leisure. This luxury will come at a premium price—and is extremely popular with couples and friends who are indulging in social spa-ing.

The pleasure and benefits derived from thermal bathing can be further enhanced with add-on treatments and therapies often conducted in private spa areas.



Credit: Myrthia Thermal Spa

Treatment rooms should be designed for multi-use and allow space for a therapist to maneuver around treatment tables.

Treatment Room Design

Though these rooms will combine the structural and design elements of a spa's main hydrothermal area, there are some unique design considerations to be aware of. In general, modern treatment rooms should have space for a shower within the room, ideally in an anteroom so the guest can shower in private. This also means the therapist's time can be used more efficiently by tidying/cleaning the room, rather than having to leave while the guest showers. The treatment surface or receptacle, whether it's a table, tub or dry floatation tank, must be in the center of the room to allow plenty of room for the therapist to access the guest.

In addition, the room will require the following:

- **Drainage:** Strategically placed floor drain(s) to catch the water run-off from the treatments. Floor drains (DN80) are in addition to any direct drain connections required by specific pieces of equipment and should include an odor cover and waste water sieve, as well as demountable grid cover.
- **Floor:** Anti-slip tiled floor with waterproof joints and an incline of at least 2% towards the floor drain.
- **Walls:** Depending on the positioning of the unit inside the room, tiled walls with waterproof joints are recommendable.
- **Shower:** Treatments may require a shower either before or after so a shower should be in the room or in an adjacent anteroom.
- **Sink:** Use a "kitchen"-style tap to enable easy filling of bowls that may be used to pour water on the guest during the treatment.
- **Electricity:** Waterproof sockets/receptacles on the floor if the treatment surface/equipment needs power; on the walls for cleaning equipment; and in the cabinetry for any concealed equipment.
- **Lighting:** Indirect, dimmable lighting that is positioned away from the guest's line of vision to prevent them being dazzled.

- **Ventilation/Air Conditioning:** To maintain a comfortable environment and correct levels of humidity, wet treatment rooms should be heated to 25° C to 35° C.
- **Floor/Wall Heating:** If used for Turkish massage, then floors and walls should be heated.
- **Audio and Speakers:** Either from a central multi-channel system or localized in the room via an MP3 player docking station for a more customized solution. Speaker should be out of the guest's line of sight if recessed into a wall or ceiling.
- **Cabinetry/Storage:** Units are needed to house specialist equipment, such as a hot towel cabinet or hot stone heater; space should be allocated for consumables that are used in various treatments; storage space is needed for clean and soiled linens; and a sink and prep area is usually required.

Structure/Finish: Built or lined using a foam-cored, waterproof, building board prior to receiving finishes, which can be selected from non-porous, fissure-free marble, granite, tile, specialist plasters or custom made, large-format ceramic panels. The finishes should be easily cleaned and suitable for high volumes of water.

Size/Space: The room must accommodate the treatment equipment, all of which will fit into a space of 1.0 m x 2.5 m, with minimum additional circulation space for the therapist at 0.8 m all around the treatment equipment, while allowing space for the shower and cabinetry. An ideal footprint for a room with a separate shower and changing area would be 6.0 m x 2.6 m measured internally.

Couples treatments are becoming increasingly popular. Installing a hydrothermal spa suite that can accommodate two person is a wise investment for any spa.

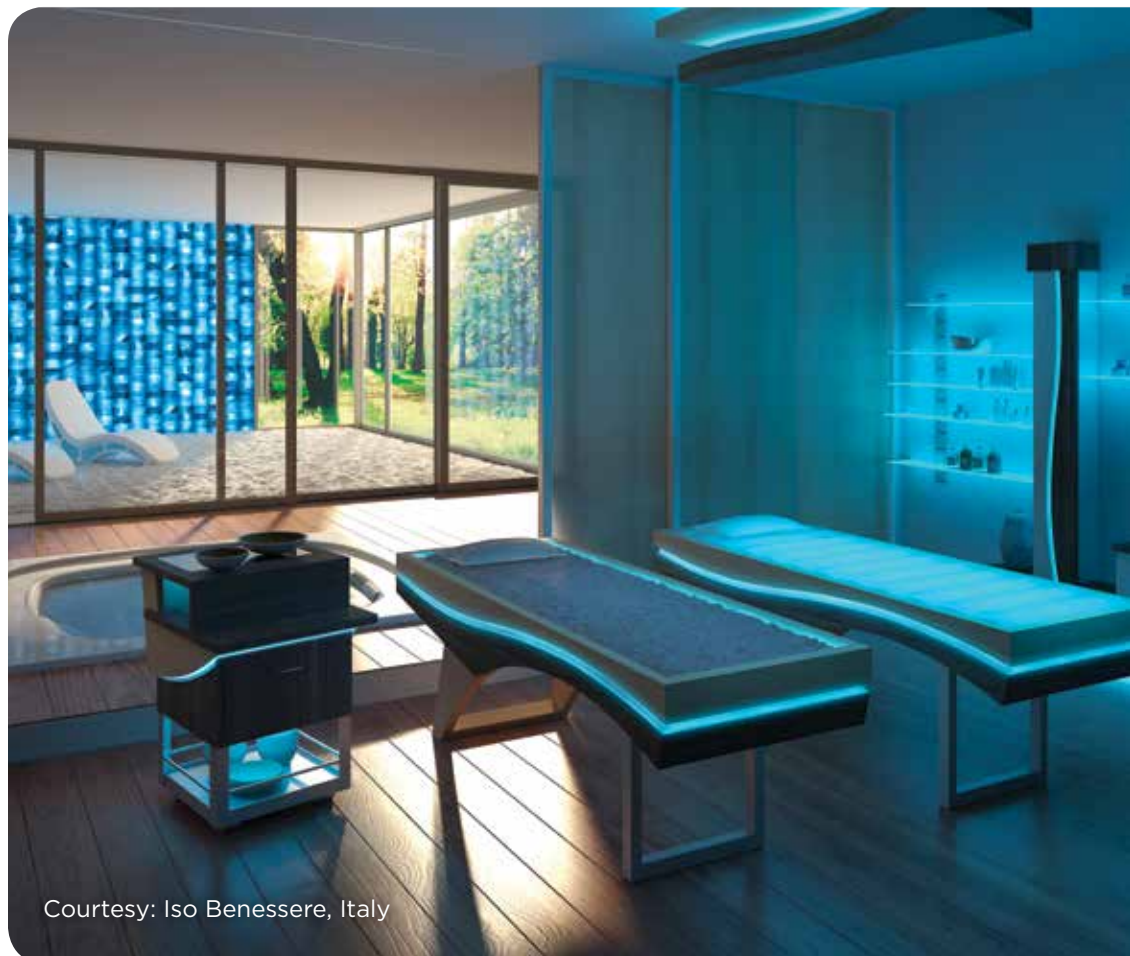

Courtesy: Iso Benessere, Italy

Common Mistakes



- Not paying enough attention to the ergonomics of tables and equipment to create a comfortable experience for both customer and therapist
- Creating difficult to clean areas—instead, make cleaning easy by using flat, smooth surfaces and a removable mattress
- Vichy shower installations must cover a client's entire body—if some areas aren't reached, the client will feel unpleasantly cold
- Forgetting to install a shower in a treatment room that will be used for wraps and mud baths
- Inadequate delivery of water—both in terms of pressure and temperature
- Residual water remaining on floor due to poor positioning of drains and slope calculation
- Noise can be extremely disturbing during treatments. This has to be kept in mind when planning both the placement of the treatment rooms (e.g., distance to dressing rooms, bar, restaurant) and the interior design of the rooms.
- Ergonomics for both guest and therapist—do everything to make both parties comfortable, such as choosing options like electrical height-adjustable beds
- Incorrect/insufficient electrical installations
- Incorrect positioning of the equipment inside the room
- Not including inspection openings for technical components when integrating equipment into individual design solutions
- Lack of attention to cleaning and disinfection when choosing the equipment
- Insufficient ventilation of the treatment rooms, especially for wet rooms (e.g., equipped with Vichy showers)
- Insufficient amount of space for storing necessary equipment and products
- Not using corrosion resistance building materials and ventilation pipework that can withstand the saline mixture in a salt/brine room
- Installing spray nozzle in the wrong place, i.e., too close to the extraction fan or too far away from the steam outlet or in the ceiling and not in the wall as the spray jet has to go horizontally into the room.
- Not using sterile brine solution



Specialist Rooms

Inhalation rooms combine steam with essential oils that target the upper respiratory tract, nose and sinuses using essential oils such as cedarwood, eucalyptus, pine, sandalwood, rosemary, tea tree and frankincense.

Inhalation Rooms

Although essential oils and aromatherapy is commonly present throughout a hydrothermal area, an inhalation room is designed specifically for inhaled aromatherapy to treat respiratory conditions. The goal of inhalation therapy (also called respiratory therapy) is to improve respiration and can be a specific treatment for chronic conditions such as asthma, bronchitis and emphysema.

Typically, an inhalation room will focus on steam inhalation combined with essential oils that target the upper respiratory tract, nose and sinuses. A variety of essential oils can be used (individually or combined); common choices are cedarwood, eucalyptus, pine, sandalwood, rosemary, tea tree and frankincense. The structure of the room will be similar to a steam room—medium-hot with a high humidity—with ergonomic benches, a low-volume steam generator, ventilation and an essential oil infuser or automatic dosing system, in which the essence of essential oils is infused into the flow of steam that enters the room.

Another option is oxygen therapy for increasing oxygen levels in the bloodstream. This is typically administered through a tube or mask at a specific inhalation station, or as part of an integral system built into a sauna, where guests are able to directly inhale oxygen via dedicated dispenser hoses.

Salt Rooms

In recent years, salt therapy has steadily grown in popularity. The concept originated in Europe when it was observed that workers in salt mines experienced a significantly reduced number of respiratory issues than their counterparts in other mines. Salt rooms and caves are specific treatment rooms that require dry conditions, good ventilation and, most importantly, the introduction of finely powdered salt into the air via a salt aerosol device (also called a “halogenerator”) or as a saline solution from a nebulizing brine vapor. The treatment is passive—the individual sits in a comfortable recliner, often with a blanket and mood music/lights to enhance the state of relaxation.

In addition to salt’s positive impact on the respiratory system—medical studies have shown that salt inhalation alleviates asthma symptoms—it is also embraced by many for its positive effect on skin conditions, with studies showing that salt can improve

a variety of skin issues, including decreasing itching, drying small fissures/scratches, and reducing of dermatitis symptoms.

The Dead Sea has attracted visitors for centuries (it was one of the world’s first health resorts) for its healing properties and Dead Sea salt can be found in a wide variety of skin care products. In recent years, Himalayan salt has been hailed for its perceived healing properties as one of the purest forms of salt in the world and is being embraced in massages and salt scrubs—with many salt rooms featuring a wall of pretty pink Himalayan salt blocks. Though these are aesthetically pleasing, they are simply for appearance sake and do not provide wellness benefits on their own.

Salt Steam Room: A salty sea climate is achieved by spraying fine nebulized brine solution into the room through a fine nozzle. Bathers can relax in a salty, humid room and inhale the hot steam enriched with salt. It’s important that both the nebulized brine solution and spraying system is sterile to avoid bacteria and germs.

Dry Salt Inhalation Room: Salt is delivered through a variety of means, including spraying fine, nebulized brine solution into the room through a nozzle, an ultrasonic mist maker or via dry salt. Here, the Microsalt SaltProX from Klafs is small, lightweight and portable—allowing users to bring the purifying pleasure of salt anywhere.



Salt is delivered through a variety of means, including spraying a fine, nebulized brine solution into the room through a nozzle, an ultrasonic mist maker or via dry salt. This photo shows the Microsalt SaltProX from Klafs, a small, lightweight portable device that lets users bring the purifying pleasure of salt anywhere they go.

Mud Bath Rituals

Mud bathing originated thousands of years ago as a medicinal and beautifying ritual—which minerals are inherent in the mud (or peloid), they can cleanse, exfoliate, absorb toxins, increase circulation and soften the skin. Though mud bath rituals that take place in private hamams or steam rooms are becoming more popular, the practice of immersing oneself or being wrapped in mud to soak up its positive affects is a long-standing practice.

Mud bath rituals typically take place in either a traditional steam room or hamam or in a specially designed “Rasul mud” area. Either a therapist applies the mud or bathers apply it to one another (this is a common couples treatment). After taking a shower, various types of mud is applied to different parts of the body. Then bathers enter a warm, herb-infused steam bath to encourage relaxation and detoxification. The mud needs to be kept moist so the correct degree of

humidity must be maintained. After 20 minutes or so, an automatic “rain” system showers the room, starting the process of removing the mud. This is usually augmented by additional showering, followed by the application of moisturizer to the body.

Design Considerations: A specialized mud bath room should incorporate showering facilities, steam and heating elements, relaxation benches/recliners and adequate drainage. The design will normally consist of two rooms: the actual mud bathing chamber and an ante room where guests can disrobe, shower post-treatment and, space permitting, receive the warm, oil moisturizing massage to complete the experience. However, a spa operator who is interested in maximizing the return on investment for their steam room or hamam, could also easily use these cabins for mud rituals.

Mud bathing has a long history and encourages relaxation and detoxification.



Courtesy: Sommerhuber



Specialist Water Treatments

Water affects both body and spirit. After a busy day, it's instinctive to crave a warm bath, or, alternatively, cool water to invigorate or alleviate swelling. Thoughtfully constructed hydrothermal experiences can tap into a bather's emotions by bringing back the memories of standing in a summer rain or sitting underneath the gentle massage of a waterfall. The following include some additional specialist water treatments to consider.

Vichy Shower

The term Vichy shower originates from the thermal spa of Vichy in France. Originally, a Vichy shower was a manual massage performed by two therapists while taking a shower. Now, the standard treatment is carried out by a therapist whose work is made easier by modern Vichy showers that allow for easy and quick adjustability of the showerheads.

The relaxing effect of the warm water on the muscles makes the body more receptive to the massage. The therapist gives a manual massage, and the water keeps the guest warm and hydrates the skin. Vichy treatments

are often combined with other treatments, such as massages, using specific products and/or body wraps or other, classic wet table treatments. The main benefits of the shower itself are increased blood circulation caused by the flow of the water, hydration of the body to fight off fatigue and prevent acne, and the reduction of stress and toxins by stimulating the nerve response in the skin.

A modern Vichy shower is a horizontal series of showerheads that form a "rain bar" over a waterproof, cushioned table that features drainage on the side for the excess water. The showerheads should be easily adjustable even with wet or slippery hands, e.g. from massage oil or soap. Choosing a height-adjustable unit adds to ergonomic working conditions for the therapist and makes it easier for the customer to enter and exit the wet table. It's highly recommended to choose a Vichy shower table with a shower arm that can be swiveled out of the way so that the room can also be used for other treatments.

Individual hydrotherapy tubs deliver a unique sensation of heat, buoyancy and hydro-massage.



Courtesy: Unbescheiden GmbH

Design Considerations: The Vichy shower and wet massage table is typically a permanent, bespoke piece of equipment that requires hot/cold water supply and drainage and adequate space for both the table and therapist—typically, a table will be 1.0 m x 2.5 m and will require a minimum of 800 mm of working room around the sides of the table. The rain-bar component is usually designed to swivel away from the table to allow for an unobstructed entry and exit on the table, in addition to creating space so that the room and table can be used for other treatments. A heated, wet table can add a further positive effect. Room temperature should be at least 27° C and forced ventilation is required.

Hydrotherapy Tub

Hydrotherapy tubs are a central part of today's modern spa and wellness facilities. Modern units offer a sequential massage, starting with the feet and going towards the upper part of the body in small steps. In addition, the massage pressure can be regulated automatically so, for example, the intensity of the massage can be reduced in the beginning and at the end of the treatment.

Individual hydrotherapy tubs deliver a unique sensation of heat, buoyancy and hydro-massage. Often used without the aid of a therapist, the jets are positioned to stimulate and relax trigger points in the body. Aromatherapy oil can be added to the baths to intensify the bather's relaxation and engage the other senses;

soothing skin products are also often featured. The natural healing power of mineral water or seawater can increase the effectiveness of the treatment. In addition, therapist-assisted treatments can be performed, which allow for the combination of both physical touch and hydro-massage. The mechanical impulse of the water nozzles provide an enhanced penetration of the massage into the body, accelerate tissue metabolism and enhance the reabsorption of metabolic waste products from the muscles which is important when treating sore muscles. As with all hydrotherapeutic applications, a key part of the underwater-pressure-jet massage is the relaxation of the muscular system inside the warm water. This enables the massage jets to deeply penetrate the muscles. From a medical perspective, hydrotherapeutic massages can be prescribed for musculoskeletal circulatory disorders, skin diseases and disorders of certain internal organs.

To intensify the effects, salts, oils and other additives can be put into the water or thermal or mineral water can be used. If this is desired, the tub needs to be equipped accordingly to avoid any issues that can be caused by additives or aggressive water. In addition, a separate air bubble function can be installed to intensify the massage.

Design Considerations: Hydrotherapy tubs should be installed to allow space for therapist-assisted treatments. To achieve the most relaxing effect, choose a tub that emanates minimal noise and keep the room at 24° C.



Courtesy: Dornbracht

Kneipp Therapy

Kneipp therapy was founded in the 19th century by Sebastian Kneipp, a Bavarian parish priest, who was ill with tuberculosis and developed this “water cure” as a way to heal himself. Kneipp therapy can be as simple as using hot and cold compresses interchangeably; however, Kneipp walks—in either real or manmade streams—are a great starting off point for Kneipp therapy. Kneipp walks use a mix of hot- and cold-water actions (stepping through the water) to stimulate blood circulation. Pebbles on the bottom of the stream/walkway massage the feet, and alternating between the hot and cold baths stimulates circulation to all parts of the body.

Kneipp hoses are frequently found in hydrothermal areas, allowing bathers to access as required. Kneipp treatments are ideal for self-application either in a hydrothermal environment or even in a bather’s own home, where bathers can integrate the positive effects of Kneipp therapy into their daily routines.

Benefits of Aquapressure

Aquapressure (targeted water massage) has similar benefits as acupuncture, helping blood circulate more freely through the body, the flow of energy is stimulated and mobility can be improved. Aquapressure targets and relieves tensions by warming the body up and then easing muscular and emotional tensions. The results are similar to a massage and can help relieve back pain, tension headaches, sleeplessness and anxiety caused by muscular imbalance.

Energizing Massage Shower

Targeted warm or cold water combined with a powerful massage relaxes and loosens neck and back muscles while creating positive energy to start the day.

Relaxing Massage Shower

Less pressure and warmer water helps bathers unwind and release the tensions of the day.





Specialist Beds/Tables

Dry Floatation Bed

Treatments on dry floatation beds are often carried out in combination with a body wrap. The bather lies on a membrane suspended within a tank filled with warm water that gives a sensation of weightlessness, while the thermic effect of the water enhances blood circulation and opens the pores of the skin, so that active components can more easily be absorbed by the body.

At the start of the treatment, the dry floatation bed is in a solid state to enable easy entry and application of the body wrap. Once applied, the air core is deflated and the guest sinks onto a heated water cushion, which results in the relaxing effect of “floating.” At the end of the treatment, the air core is inflated and solidifies again so as to better support the guest when leaving the unit.

Due to their stable lying surface, some units can also be used for manual massages. A multitude of different treatments can thus be performed inside one room using the same unit.

In addition to the relaxing effect of “floating,” the benefits of dry float will depend on the products being used. Cosmetic, dermatologic or therapeutic packs are applied. The warmth of the water supports the effect of the packs, making their absorption into the skin much easier. An additional benefit is the feeling of sinking into and lying in, or rather on, a surface of water.

Design Considerations: The room temperature should be kept at around 24° C and the necessary equipment for the body wraps (e.g., the stirrer for the preparation of the media or the water for the warming and storing of body wraps) should either be in the same room or in a nearby central preparation unit. If the latter is the case, it's important to ensure easy and quick access of the necessary equipment. A shower in the room or very nearby is vital for the guest to remove the media used during the body wrap.



Courtesy: Unbescheiden GmbH

Dry hydrotherapy tubs allow bathers to experience the healing effects of water, heat and massage without disrobing.

Body Wraps

Body wraps are often paired with dry floatation treatments. Body wraps can be partial (treating only parts of the body) or full body.

Varying products and media are used in body wraps, and the benefits correlate directly to the components present in the media. Traditionally, wraps were predominantly mineral-based (sludge, mud, peat, moor) and, today, many treatments still use similar organic materials. In addition, wraps are now often complemented with cosmetic, dermatologic or other products.

A few examples of the wellbeing benefits:

- Detoxification (peloids and algae)
- Revitalization (cosmetic wraps, peloids, algae)
- Slimming (algae)
- Reduction of cellulite (algae)
- Moisturizing of the skin (cosmetic products)

Not only does the heat used in these treatments encourage the absorption of the media by the body, but it also helps promote relaxation, relieve stress and even work to increase blood circulation.

Body wraps are often applied on a standard therapeutic table, however, dry floatation systems can offer a better experience. The dry floatation bed will have a solid surface in the beginning, making it easier for the customer to lie down and enable the application of the body wrap. After, the guest sinks into a cushion of warm water and experiences a “floating” feeling. The warm temperature of the water supports the effect of the body wrap. When the treatment is coming to an end, the surface of the bed will become solid again, and the guest will be moved up, out of the water cushion, making it easier to exit the bed.

Dry Hydro Massage Bed

Dry hydrotherapy (or a dry water massage) allows a bather to experience the healing effects of water, heat and massage without ever getting wet. The benefits of hydrotherapy tubs are well documented, however there are drawbacks, including high operating costs, risk of injury (especially to the old or infirm) and, of course, cultural aversion to disrobing in public.

A dry hydro massage bed's water jets are located beneath a rubberized cover and provide the effect of a gentle hydro massage. The units are usually height-adjustable, allowing for ergonomic working conditions for a therapist and easier access for the guest.

Design Considerations: Dry hydro massage beds should be installed to allow space for any therapist-assisted treatments.

Hot Sand/Salt Beds

In a traditional sand bath (also referred to as psammo therapy for the Greek word for sand), bathers buried themselves in sand heated by the sun. The resulting warm, cocoon-like environment is described as

surprisingly supportive and profoundly relaxing both physically and mentally.

Today, traditional sand baths are offered in warmer climates, such as Egypt, Morocco and the Middle East; while Japan has an extensive history of sand bathing, particularly where the sands are rich in certain minerals, and sand baths are often offered at sites where traditional onsen mineral baths are available.

Anyone can create a sand bath—simply dig a shallow hole in the sand and wait until the sun has warmed it, then recline face-up while someone buries you; once cocooned, enjoy the feeling weightlessness and warmth for around 10 to 20 minutes. At a professional facility, there will be attendants on hand to make sure bathers are protected from any glaring sunshine while making sure they stay hydrated during the bath.

In a modern spa, sand or salt might be used interchangeably, depending on the guest's preference. Either way, these beds bring the bliss of the beach to guests wherever they may be in the world.

Hot sand baths in today's spas are luxurious and often feature specialized quartz grains that store heat and provide a cradle-like environment for the body.



Courtesy: Gharieni Group



Pool Areas: Function and Design

The benefits of having a pool or pools—whether full-size lap/exercise pools or vitality pools—in a spa are numerous.

“Hydrotherapy” is a term often used to describe the use of water therapy for relaxation, pain relief and treatment.

Specially designed pools are a great way to take advantage of the physical properties of water, including temperature and pressure, to promote relaxation and healing of the body.

Hydrotherapy offers a wide array of health benefits, whether combining soothing water temperature with jets and other features for self-massage; using a shock of cold water to stimulate blood circulation; or using the advantage of water for low-impact exercise—the weightlessness of a person’s body in water means swimming offers the only way to exercise without a harsh impact on the skeletal system.

This chapter looks closely at how pools work and introduces the reader to the construction and design considerations to be made when adding a pool to a spa or home.

Pools play a key role in hydrotherapy, promoting relaxation and stress relief.

Common Spa Pools

Pool Type	Health & Wellness Benefits	Temp (deg. C)*	Depth	Minimum Water Turnover Rate
Lap/Exercise	<ul style="list-style-type: none"> • Exercise & fitness • Water aerobics 	27 to 29	Variable; 1.0 m to 1.2 m	4 hours
Hydrotherapy/ Vitality	<ul style="list-style-type: none"> • Massage and relaxation • Increase muscular power • Increase range of joint movement 	34 to 40	1.0 m to 1.2m	0.5 to 1.5 hours
Onsen	<ul style="list-style-type: none"> • Relaxes muscles • Improves mobility 	34 to 40	1.0 m to 1.2 m	0.5 to 1.5 hours
Cold Plunge	<ul style="list-style-type: none"> • Stimulates circulation 	12 to 20	1.5 m	20 to 30 minutes
Floatation	<ul style="list-style-type: none"> • Pain and stress relief 	34 to 40	1.0 m to 1.2 m	0.5 to 1.5 hours
Watsu	<ul style="list-style-type: none"> • Relaxes muscles • Improves mobility 	34 to 40	1.0 m to 1.2 m	0.5 to 1.5 hours
Saltwater/ Mineral	<ul style="list-style-type: none"> • Stress relief • Provides energy to the body • Calms the nervous system • Eliminates/reduces skin irritation • Moisture to the skin 	32 to 36	1.0 m to 1.2 m	30 to 90 minutes
Kneipp Walk	<ul style="list-style-type: none"> • Stimulates circulation • Stress relief • Helps relieve joints 	15 to 20 (cold), 30 to 35 (hot)	200 mm to 600mm	0.5 to 1.5 hours

*Temperatures may vary depending on geographical location and if pool is indoor or outdoor.



Lap/Exercise Pool

Lap/Exercise Pool

Temperature: 27° C to 29° C

Depth: Variable; average 1.0 m to 1.2 m

A pool that is large enough to exercise in offers significant benefits. The size of the pool will be determined by the space available and the types of exercising required—for example, different specifications are required for resistance training versus swimming lengths/laps. As a guide, an exercise pool that can accommodate 10 people should be approximately 20 m x 6.5 m x 1.2 m deep, while a traditional lap pool is 25 m long x 12.5 m wide. Where space constraints exist, the use of counter current/swim jets allow on-the-spot exercise.

Benefits

As mentioned previously, swimming is the lowest-impact aerobic exercise available. When the human body is submerged in water, it automatically becomes lighter. In fact, when immersed to the waist, the body bears just 50% of its weight; when immersed to the chest, it reduces to approximately 25% to 35%; when immersed all the way to the neck, the body bears only 10% of its own weight. This type of weightlessness is unattainable any other way.

This means that exercising in a pool is ideal for working stiff muscles and sore joints. The Arthritis Foundation suggests the ideal exercise for relief is one that stretches and strengthens muscles while delivering an aerobic workout—such as doing laps in the pool.



Hydrotherapy/Vitality Pool

Hydrotherapy/Vitality Pool

Temperature: 34° C to 40° C

Depth: 1.0 m to 1.2 m

The combination of warm water (average temperature 38° C) and a selection of water features, including air tubs, swan-neck fountains, air loungers and water jets, means hydrotherapy/vitality pools provide unique benefits, including the cleansing and detoxification of the skin, relieving tired and aching muscles, increasing circulation and relaxing the mind and body.

The difference between the two pools is that hydrotherapy pools are typically much larger than vitality pools and allow guests the ability to “walk” or “float” a course of water features; a vitality pool is more akin to what is often called a “Jacuzzi” (the brand name that has become synonymous with pools with water jets). Vitality pools offer a mini-hydrotherapy experience and are typically used where space will not permit the inclusion of a full-size hydrotherapy pool.

Benefits

These pools deliver true *external* hydrotherapy—the complete immersion of the body in hot water, serving to relax muscles.



Vitality pool features, like swan-neck fountain (top); air recliners (middle) and air tubs (bottom), increase relaxation and stress relief.



Onsen Pool

Onsen Pool

Temperature: 34° C to 40° C

Depth: 1.0 m to 1.2 m

This pool originates from Japan—and plays a big role in the country’s ritual bathing practices. “*Onsen*” actually translates as “hot springs” in Japanese, but has come to refer to the natural spring baths found throughout Japan.

Traditionally, onsens were used outdoor. They are most often made from Japanese cypress, marble or granite, while indoor tubs are typically constructed of tile, acrylic glass or stainless steel.

Benefits

Since *onsens* use natural hot springs, their benefits are closely dependent on the mineral properties and content of the water itself. But typical benefits include the easing of neuralgia, alleviation of muscle pain and the reduction of the symptoms of chronic skin disease. Onsen bathing is also believed to relieve chronic fatigue and stress.



Due to its extensive volcanic activity, Japan has thousands of geothermal hot springs around the country. Japanese onsens come in all shapes, sizes and configurations and the health benefits derived from each differs dependent upon the minerals and elements present.



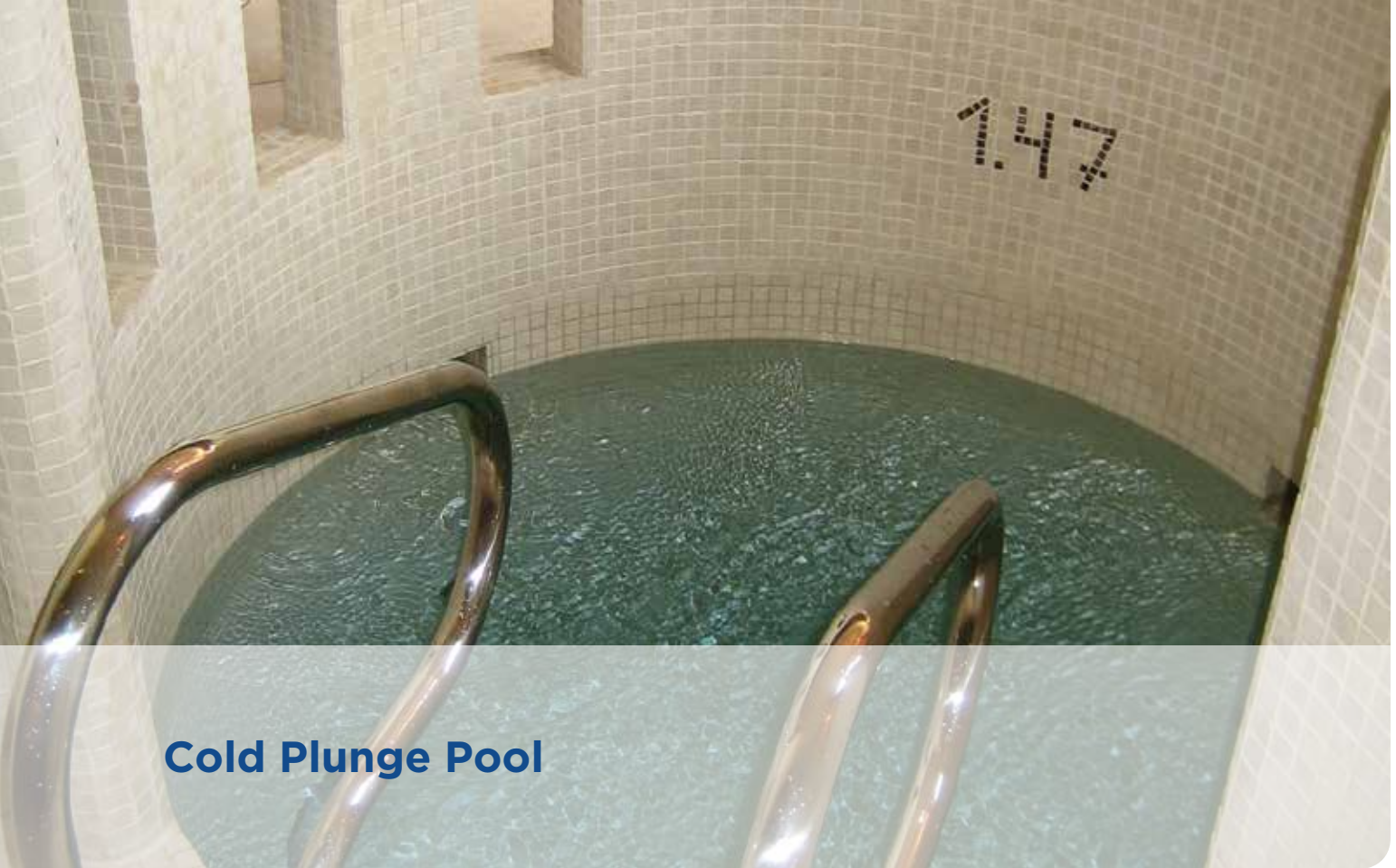

Cold Plunge Pool

Cold Plunge Pool

Temperature: 5° C to 20° C

Depth: 1.5 m

A cold plunge pool is typically entered after and between hot thermal treatments to cool bathers down.

Going from a heated environment to a cold plunge, which is usually kept at about 10° C to 15° C, stimulates the body in several ways. A quick, 30-second dip is enough to kick start circulation and dilate the vascular system, delivering the positive therapeutic effects of hot/cold contrast therapy.

Benefits

First, the cold water numbs the nerves around joints and muscles. It also causes the release of endorphins and hormones with analgesic properties. Not only does this alleviate some joint pain but muscle aches as well. The cold-water plunge is also believed to stimulate the immune system.



Specialty Pools

Floatation Pools / Tanks

Temperature: 34° C to 40° C

Depth: Pools - 1.0 m to 1.2 m
Tanks - Approximately 0.5 m

Watsu® Pool

Temperature: 34° C to 42° C

Depth: 1.0 m to 1.5 m

Mineral Pool

Temperature: 32° C to 36° C

Depth: 1.0 m to 1.2 m

Kneipp Walk

Temperature: 15° C to 20° C (cold) and
30° C to 35° C (hot)

Depth: 250 mm to 450 mm

Floatation Pools

Temperature: 34° C to 40° C

Depth: 1.0 m to 1.2 m

A floatation pool or tank is usually enclosed and typically measures approximately 2.5 m long x 1.2 m wide. The water in the tank is kept at body temperature. The most important element of the tank is the addition of magnesium sulfate (Epsom salt) that is dissolved in the tank: approximately 400 kg of Epsom salt to 200 gallons of water—this is what creates the weightless “float.” As opposed to a swimming pool where there is a sense of weightlessness, gravity in a floatation tank is completely nullified by the buoyancy caused by the dissolved Epsom salt.

Unique to the enclosed floatation tanks is the sensory deprivation they provide. This restricted stimulation has been proven to change the way the brain works, showing an increase in theta waves in the brain¹—the waves that are activated by meditation and active during REM sleep.



Socializing plays a very important role in hydrothermal bathing. Here guests enjoy the mineral pool at Peninsula Hot Springs, Victoria, Australia.

Benefits

The increase in theta waves is thought to reduce stress and encourage a happy, contented brain. The physical benefits of floating in magnesium sulfate also gives those that suffer from joint and/or muscle pain huge relief by taking away the effects of gravity on the body. There is also the innate benefit of absorbing the Epsom salt through the skin, which is full of magnesium, something many people are deficient in. Raising magnesium levels can improve circulation, ease muscle pain and relieve stress².

Watsu® Pool

Temperature: 34° C to 40° C

Depth: 1.0 m to 1.2 m

These are pools designed specifically for Watsu massage, a gentle form of body therapy performed in warm water. It combines elements of massage, joint mobilization, shiatsu, muscle stretching and dance. The receiver is continuously supported while being floated, cradled, rocked and stretched. This typically requires a 3.5-meter diameter pool for single treatments, and a larger pool if the desire is to give simultaneous treatments.

Benefits

Watsu massage is designed to induce a state of deep relaxation to the body and the mind and relieve stress. Because it's such a gentle treatment, it's also good for

the elderly and children. The weightlessness effect of the water provides for gentle stretching and joint mobilization. This treatment is often used to treat different conditions like brain injury, stroke, spinal cord injury, Parkinson's disease, cerebral palsy, arthritis and fibromyalgia. It is also used to treat chronic pain and in post-surgical or post-trauma recoveries.

Mineral Pool

Temperature: 32° C to 36° C

Depth: 1.0 m to 1.2 m

Mineral pools come in all shapes and sizes—they can be full size pools, wading pools or vitality pools. The water temperature of mineral baths may be hot, warm, cool or even cold. Mineral waters can have an acidic, basic or neutral pH, depending on the types of dissolved solids in the water. Some mineral waters contain arsenic or other toxic substances and should never be used for drinking water, unless specified that it is all right to do so.

Benefits

Throughout the centuries, mineral spas and pools have been enjoyed on many levels, including for cleansing, social and health benefits. Today, the healing benefits of the natural mineral springs—referred to as balneotherapy (see page 128)—are well-known and usage of hot springs is on the rise.

Kneipp Walk

Temperature: 15° C to 20° C and 30° C to 35° C

Depth: 200 mm to 250 mm

The Kneipp walk is a water treatment using a mix of hot and cold water actions (stepping through the water) to stimulate the metabolism of tissues and the circulation of blood. Pebbles on the bottom of the stream/walkway massage the feet, and the alternation of hot and cold baths stimulate circulation of all parts of the body.

There are two walks used—the bather begins by stepping in hot water for one minute to two minutes (the water is usually lit up with color), and then moves to the cold-water pool (usually lit light blue) for half a minute. The process is repeated approximately three times. A handrail is often used to help the bather walk through the different water pressures. Kneipp walks can be located anywhere within the spa journey and are often used as a feature by designers, creating interesting paths and walkways.

Benefits

Kneipp therapy was created in the 19th century by Sebastian Kneipp, a Bavarian parish priest, who fell ill with tuberculosis and strongly believed that his use of a “water cure” healed him. Kneipp therapy is well-respected and even subsidized by the government in some European countries for both preventative and rehabilitative purposes. Kneipp therapy does not have to take place in a pool—in fact, hot and cold compresses can be used—but pools are most common.

Applications of hot and cold water have long been used to cure headaches, improve lymphatic function and even eliminate hangovers. Kneipp walks are often used in treatment for conditions from arthritis, abscesses and heart disease to asthma, diabetes and allergic eczema.

Kneipp walks use hot and cold water to stimulate circulation and overall wellbeing.





Courtesy: Center Parcs UK

A well-designed pool is an aesthetically-pleasing focal point.

Common Mistakes



- Chemical smells permeating nearby areas
- Floor slippery and dangerous
- Bulbs in the pool difficult to replace
- Poor overflow drainage
- Inadequate filtration and water treatment plant space
- Insufficient provision of MEP services—power, water, drainage etc.
- Inadequate water turnover rates leading to poor water quality
- Adopting high filtration rates leading to poor water quality
- Lack of secondary disinfection (e.g. UV) leading to excessive chemicals in the pool
- Poor provision for the delivery of chemicals to the plant room
- Inadequate filtration and poor chemical balance causing poor water quality
- Failing to backflush filters on a regular basis - once a week minimum or when the indicated by inlet and outlet pressure gauges

Pool Area Design

When designing pool areas, it is important to remember that people interact differently when minimally clothed. This means there is an increased need for personal space.

Special consideration should be given to corridors, passageways and circulation spaces where guests travel in opposite directions. Pinch-points should be avoided, and poolside relaxation spaces should be designed with personal space in mind. If there is food or beverage service offered in these areas, then space for staff to attend to guests and tables for service items should be provided.

In addition, benches and seats in the pools need to allow for adequate space between bodies (600 mm is recommended); where possible, it's advised to provide individual seating so that bathers don't have to consider invading another's personal space on a communal bench. Seats should also be shaped to allow for comfort and space where air jets might push the bather away from the seat back.

To create a bather-friendly environment, pools should also have sufficiently wide treads and short risers for entries and exits and no sudden drops at the junction with the floor.

Surface Finishes

Surface finishes for pools should be selected based upon several criteria: safety, hygiene, ease of maintenance and visual appearance. Natural stone is a popular finish in pool areas; however, these don't carry slip-resistance ratings like manufactured tile finishes. Natural finishes, such as slate, should be carefully selected, as many varieties have a tendency to de-laminate, and any marble finishes with fissures should be avoided. Limestone, in all its various forms, should generally be avoided in wet areas, as it is not only very soft and easily eroded, but species like Travertine can be very heavily fissured. Even though these tiles can be supplied with fissures filled with a resin-based material, new openings will inevitably form during use.

If choosing natural stone, it's important to use a testing agency to test slippage. The cost for this is minimal and is highly recommended, as it demonstrates due diligence. Of course, it's also imperative to choose floor surfaces that minimize the potential for slippage and use the correct sloping angle³ for proper drainage. It's worth noting that the requirement for non-slip surfaces is only in critical areas, including the treads of the steps and the top of the slope inside the pool down to the deeper areas.

Pool Types

The aesthetics of a pool are very much affected by the type of pool chosen. There are two types of pools: overflow and freeboard. An overflow pool is most commonly chosen for hydrotherapy spas because they can be level with the decking or designed as infinity pools. On the other hand, in a freeboard/skimmer pool, the water level is approximately 150 mm below the pool deck, creating a visible edge.

Not only do the pools look very different, but they also function differently in terms of how they handle the treatment and flow of pool water. An overflow pool uses a balance tank to store and treat the overflow of surface water that runs off when people get into the pool. The displaced water is captured, treated and then

pumped back into the pool. A skimmer pool, instead, does not have the inherent benefit of constantly renewing its surface water because the displacement is handled by the water level rising versus vacating the pool.

This means overflow pools are very efficient when it comes to removing and treating polluted surface water. This is important because surface water, which holds approximately 75% of a pool's pollution, is often ingested by swimmers.

Access for Persons with Disabilities

- The route to the pool must not be confusing and lead directly through a shower area.
- Handrails should be provided between the changing rooms and poolside, and tactile information must be placed at critical points on circulation routes.
- Design and detailing at the pool edge is critical to warn swimmers they are approaching the pool edge.
- The minimum water depth to provide sufficient buoyancy for adult disabled swimmers is 1,200 mm. However, learner pools should be accessible to disabled children and other groups who may prefer a shallower depth of water.
- Moveable floors can be particularly useful in learner pools, as they provide the deeper water necessary for adult swimmers with a lower-limb disability.
- Disabled swimmers can access the pool by a variety of means with a ramped entry or hoist being the minimum requirement.
- Floor finishes must be reliable and slip-resistant with a non-abrasive surface.

Design Considerations

Pools are complex to build and manage. User safety, efficient water treatment and pleasing aesthetics start with careful planning, specification and design.

The water treatment system must be an integral part of the architectural, structural, mechanical and electrical design of the building. It is critical at the earliest stages of a project, after determining the type of pool(s) being installed, to consider the following key factors:

- Anticipated bather load (required to determine pool and plant sizing)
- Pool size and volume (length x width x depth), plus any hydrotherapy equipment to be incorporated into the pool
- Pool location
- Balance tank location
- Plant room location and size
- Level of pool, balance tank and plant room are of paramount importance

Pool Tank/Basin Construction

Pool tanks or basins (the pool structure itself) can be built from various materials, including concrete, stainless steel or fiberglass. There are some functional and aesthetic differences between these materials.

Concrete: A common, affordable choice, but pools rendered in concrete can suffer from water leakage. It's important to conduct a percolation test to ensure water integrity before tiling a pool built from concrete.

Stainless Steel: Popular for both its aesthetic value and water retention ability. A minimum grade 316L stainless steel, which is more resistant to corrosion than conventional stainless steel, should be used for freshwater pools. If the pool is saltwater, a higher grade of stainless steel is required. Modular stainless steel is also an option. Here, the stainless steel panels have a PVC lining. The modular design makes them quick to construct and removes the need for hot welding on site.



Indoor pool at
Tschuggen Grand
Hotel, Arosa,
Switzerland.

Fiberglass or Glass Reinforced Plastic: Offer great water retention and can be delivered as a single piece or in sections for construction on site.

Pre-Formed, Composite Shell: A next-generation pool structure. Pre-formed, composite shells combine three materials working together to create a bespoke, tiled pool that is quick and easy to install. Pool shells are manufactured out of fiberglass with an epoxy-laminate layer to ensure waterproofing and finished in a ceramic mosaic tile; finally, the fully finished pool is delivered directly to the site, ready for installation

Pool Finishes

Pools are usually finished in tiles, either mosaic or larger format. And non-slip tiles are essential around stairs and shallow areas. Natural stone or slate is not recommended because it is porous and can discolor, leaving a residue on the pool floor. If considering such materials, test them with pool chemicals prior to installation.

In order to increase waterproofing, a rendered finish can be used. The rendered finish is applied between the concrete structure and the finish tile.

Stainless steel pools are usually left bare (versus tiled) and can be polished to produce either a satin-brushed or mirror finish.

PVC liners are often used in large, public pools where there's a need for an affordable pool finish that is watertight. These flexible membranes can be applied to both concrete and stainless steel pools. They come in various colors.

Pollution and Cleaning

Pollution in swimming pools' water comes from many sources; however, swimmers themselves are the major source. In fact, it is said that each swimmer can introduce as much as 600 million bacteria into the pool! In addition to bacteria, there are other pollutants caused by swimmers, like perspiration, cosmetics, suntan lotion, hair products, sweat, urine, etc.

Interestingly, the chemicals used to treat pool water can also create their own problems. A key mistake in water treatment is when an operator uses five or six chemicals to keep the water in balance. These

Guide to Pool Pollution

Surface Pollution: Hair, dust, grease, excreta, floating debris, grass, etc. This can often be handled by an efficient surface draw-off system, such as those found in level-deck pools. Of course, larger items of surface debris can be removed by the pool staff.

Dissolved Pollution: Urine, perspiration, cosmetics, etc. Efficient filtration and circulation is critical for treatment, as well as maintaining sufficient chlorine levels for breaking it down.

Suspended-Matter Pollution: Water treatment and cleaning chemicals. To deal with these, use the minimum quantities of chemicals in and around the pool and maintain carefully balanced water.

Insoluble Pollution: Fluff, dirt, precipitated chemicals, filter sand, etc. Sweep or vacuum the pool bottom daily or as required.

can include: hydrochloric acid (for pH correction), sodium bicarbonate (for alkalinity adjustment), alum (as a filter aid), calcium flake (for grout protection) and sodium thiosulphate (used for over chlorination). Scum line cleaners and poolside cleaners can also find their way into the pool.

With careful management and selection of the correct sanitizer, as few as two or three chemicals can do the same job with better results.

How Pools Operate

When considering the installation of a pool, it's important to understand how they work, especially in regards to filtration and water treatment.

All the pool water must be filtered and treated to keep the pool safe and clean—and determining how long it takes to move the entire contents of a pool through the filter system is called “turnover rate.” The turnover rate required helps determine the pool pump that is needed. A higher-use pool with more water will require more frequent turnover.



**Overflow:
Level Deck**

Pool water is level with the pool surroundings. Aesthetically pleasing and inherently cleaner because most of the polluted surface water flows over the edge of the pool into the transfer channel connected to the balance tank.

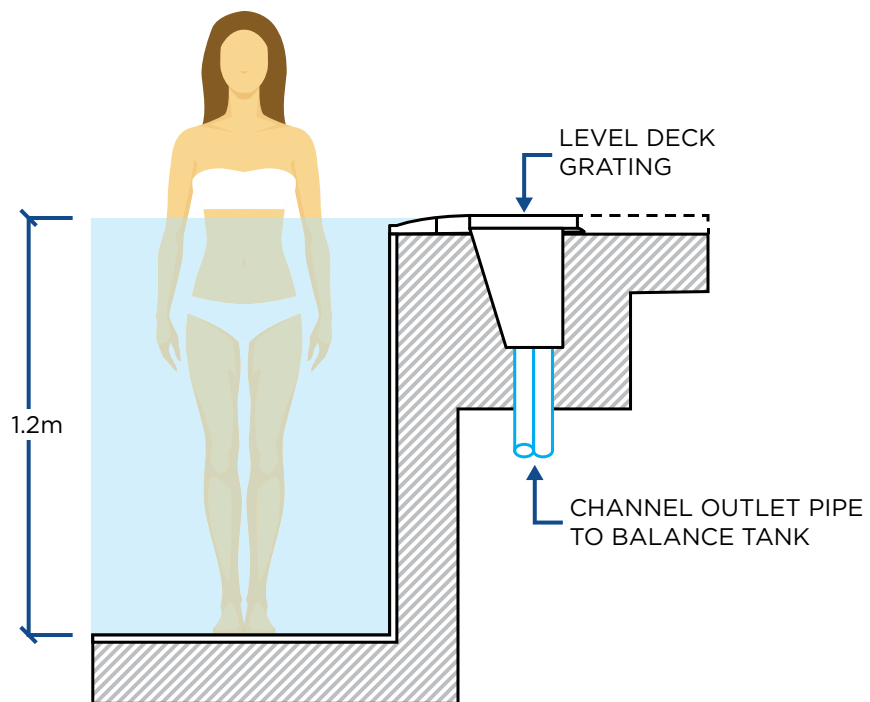



Overflow:
Infinity Edge

Similar to level-deck pool, but the water is transferred to an overhanging channel and gives the visual appearance of the pool water blending (merging) with the horizon.

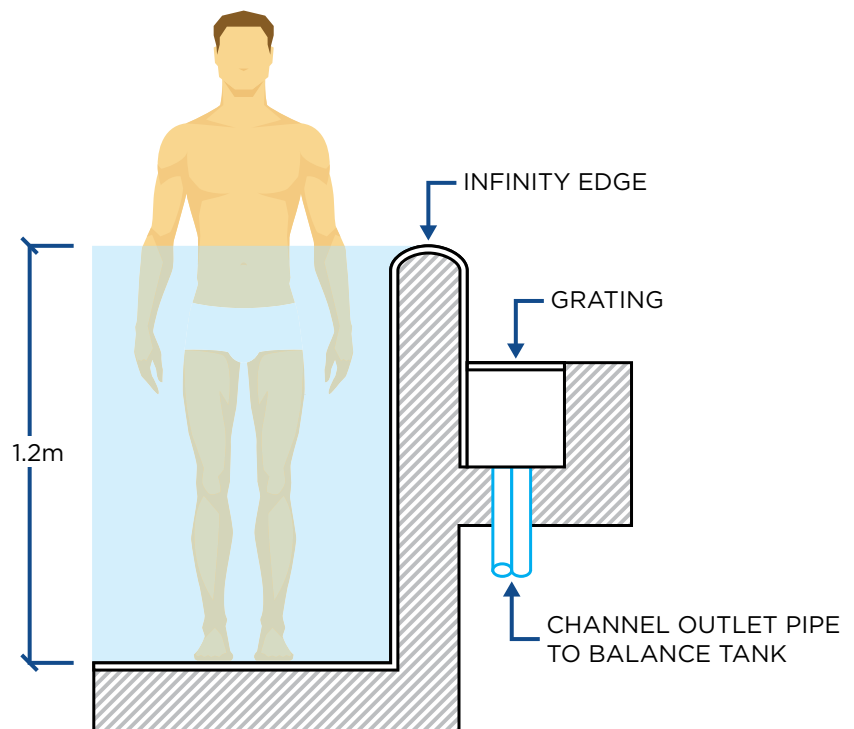



**Freeboard:
Skimmer**

Space between the water level and the top of the pool deck.

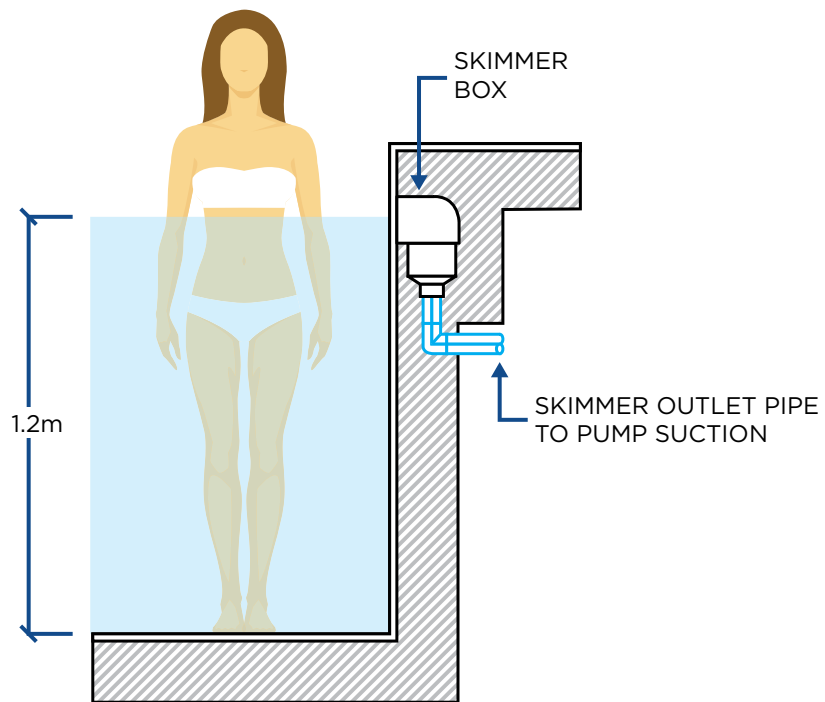

Pool Water Safety

Pool staff should be trained to conduct regular testing of the pool water. Below are testing guidelines:

Daily Tests (Every 2-3 Hours)	Water Quality Values
Free Chlorine	Range 0.5 to 3.0 mg/l (Aim for 1.0 to 2.0 mg/l)
Combined Chlorine	Not more than one third of total chlorine
pH	Range 7.2 to max. 7.6 (Aim for 7.2 to 7.4)
Weekly Tests	Water Quality Values
Alkalinity	100 ppm to 180 ppm Sodium Hypochlorite 100 ppm to 120 ppm Calcium Hypochlorite
Calcium Hardness	200 ppm to 1000 ppm (not less than 200 ppm)
TDS	Total Dissolved Solids Max. 1000 ppm above source water
Pool Balance	Refer to Langelier Saturation Index

Pool Chemical Room Safety

Careful consideration has to be given for safe delivery of chemicals, including offloading and transfer within the building, avoiding stairs where possible.

Storage: Adequate, separate storage and containment space must be provided for the chemical containers and bags required for the normal daily and weekly refilling of the operational chemical day tanks.

Containment Bunds: A chemical bund area should be constructed in concrete with a cement render internally and finished with a chemical-resistant (or fiberglass-lined) material, providing a fully contained bund capable of holding 110% of the maximum chemical volume.

Segregation: Separate enclosures should be maintained for all potentially hazardous chemicals (acids and alkalis) in separately ventilated rooms, with a minimum of four air changes per hour.

Drench Showers/Eyewashes: Emergency drench showers/eyewashes are recommended in commercial chemical rooms.

Eyewash: A sealed sterile type of eyewash bottle should be located near the intake point and in the chemical stores

Sink: A large sink with hot and cold running water is required for cleaning the chemical injectors.

Filtration Water Treatment Flow

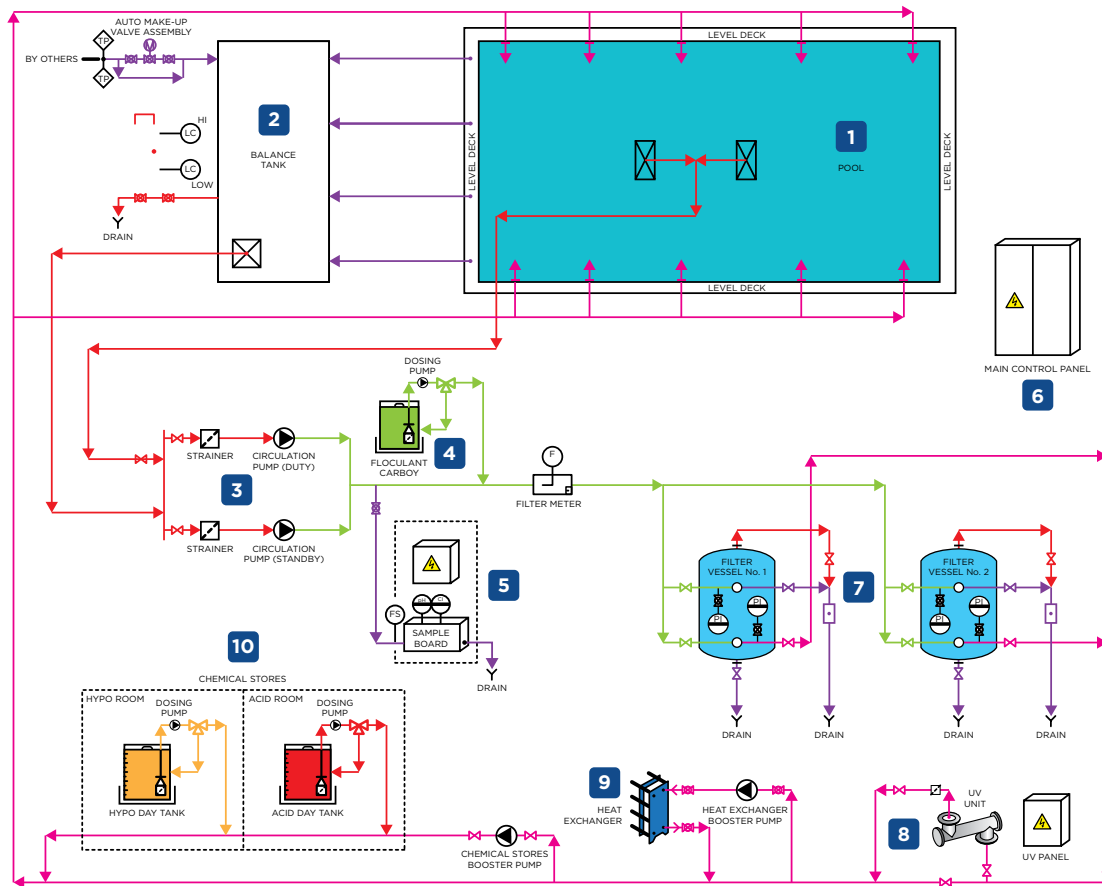

1 - Pool Tank/Basin

The pool illustrated here is a typical level-deck pool with concentric bottom-sump outlets and wall inlets evenly positioned to provide the best possible water distribution. It is recommended that outlets have a maximum velocity of 0.5 m/second for suction and 0.5 m to 1.0 m/second for inlets. All pool fittings should be designed in compliance with international pool entrapment standards, which means no gap greater than 8 mm. In larger pools, it's recommended to include vacuum points for pool cleaning so automatic pool cleaners can clean the pool overnight.

2 - Balance Tank

Balance tanks are required for all overflow pools in order to contain the “surge” caused by bather displacement, whether level deck, infinity edge or other variation. Bathers entering the pool displace water to the overflow system, which feeds pool water to the balance tank.

This effectively drops the pool water level.

Fresh water is introduced into the system via an auto make-up system in the balance tank and the pool inlets return the height of the pool water to normal.

3 - Circulating Pumps

Main circulating pumps are at the heart of the filtration system, and their selection is crucial to the continuous operation of the filtration and water treatment system. Upstream of the main circulation pumps, strainers should be fitted to protect the pumps from any pool debris. (These should be inspected and cleaned on a weekly basis.)

4 - Flocculation Dosing System

Incorporating the continuous dosing of a coagulant in very small quantities is an effective way to remove microscopic impurities and organisms from a pool, including common waterborne parasites, like cryptosporidium, the germ that causes diarrhea.

5 – Chemical Controller

Monitors and regulates pool chemical levels.

6 – Electrical Control Panel

Electrical control panels are required to provide power to all of the electrical equipment in the plant room and to provide overload protection to the equipment. The electrical control panel can also be linked to the Building Management System, providing fault signals to a central control room.

7 – Filtration

Good filtration is essential for ensuring water quality. The most common filtration method for commercial usage is medium-rate, vertical sand filters, but there is also regenerative, diatomaceous earth and cartilage filtration to consider. Of critical importance is the filtration rate—the higher the rate, the lower the filtration efficiency. *Note: Filtration rates should not exceed 25m³/m²/hour (flow rate/area of flow rate/time).*

8 – Secondary Disinfection

It is strongly recommended to have a secondary disinfection process in place to fight waterborne parasites. There are several options available:

- Full Ozone: Ozone gas is used to complement chlorination and results in lower levels of chlorine; however this requires a good level of expertise to operate, additional space in the plant room and is more expensive to install and run.
- Ultra-violet (UV): Commonly used to complement chlorination and allows pools to operate with lower levels of chlorine.
- Partial-Flow UV or Ozone: an alternative when there are space restrictions as only a 10% to 25% of total flow rate is treated so not as effective as full-flow treatments.

9 – Pool Heating

Common methods of heating are gas and/or oil boilers; electrical heating; heat exchanger (particularly used in very hot countries).

10 – Chemical Injection

Automatic chemical dosing systems are recommended where possible.

Pool Chemical Primer

Disinfectants

- Sodium Hypochlorite: Supplied in liquid form either in small pack or bulk with a maximum chlorine strength of 15%. Widely used in pools where hard water is the source water.
- Calcium Hypochlorite: Supplied in granular and tablet form with a maximum chlorine strength of 65% to 68%. Most often used in pools where soft water is the source water.
- Bromine: Supplied in granular or tablet form, bromine is an alternative to chlorine. Though closely related, bromine is able to withstand heat better than chlorine so is recommended for spa pools, but isn't ideal for larger commercial pools.

pH Correction

- Sodium Bisulphate: Supplied as a dry powder to be mixed in water.
- Hydrochloric Acid: Supplied in concentrated liquid form, requires dilution and is very gaseous.
- Sulphuric Acid: Supplied in concentrated liquid form, requires dilution. An exothermic reaction occurs when added to water.
- CO₂ Gas: Supplied in either small pack container or bulk, this product is not advisable to be used within a pool that has air features, as the gas will escape into the atmosphere while the water is agitated, reducing the effectiveness of the CO₂ gas and making the control of the PH difficult to manage.

Alternative Disinfection Treatments

- Frequently new water treatment processes enter the market with bold claims of providing chlorine-free disinfection or chemical-free disinfection. In certain circumstances some of these treatment processes may bear further consideration, but always obtain independent professional advice before using and don't simply rely on the marketing claims provided by any one supplier.

Plant Room Design

Plant rooms need to be considered in the very early stages of the design process. There are numerous reasons for this—including the fact that they will invariably take up more space than operators might anticipate. They also require input from a structural engineer to ensure that the foundation is capable of holding the weight of the balance tank and filtration and water treatment plant. And, finally, plant rooms must be situated in areas that allow for the minimizing of noise and vibration.

Plant Room Design Considerations

Foundation: A structural engineer should ensure that plant room slab is capable of holding the working weight of the balance tank and filtration and water treatment plant.

Noise Reduction: Plant rooms should be strategically located to keep noise to a minimum in other areas of the spa. In addition, every effort should be made to minimize noise and vibration. For example, typical equipment noise levels for main circulating pumps are >80dba, and air blowers are >85dba. Insulated acoustic panels and/or doors should be incorporated.

Drainage: Gullies are required for main circulating pump strainers, filters, chemical rooms and chemical controllers/sample boards. In addition, a dedicated back-wash connection is recommended for each filter.

Level: Plant room slab level needs to be a minimum of one meter below the pool static water level. If this is not possible, than a pump pit should be incorporated into the plant room. Should the drainage level be higher than the pit, a recess sump should be incorporated and an automatic sump pump installed to drain.

Water Hydraulics

For effective water hydraulics, the levels of the pool static water, balance tank and main circulating pumps are of critical importance; examples of good design are shown here.

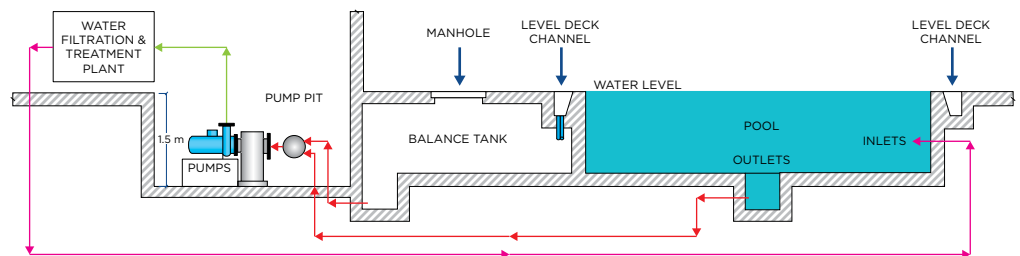

Option 1: Pool Water Treatment Plant on Same Level as Pool

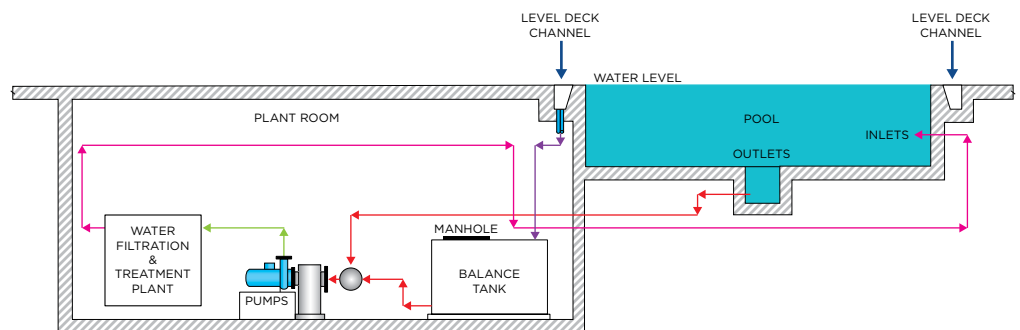

Option 2: Pool Water Treatment Plant & Balance Tank on Level Below

Space: The amount of space required to house the pool filtration and water treatment plant vary considerably depending on the number and size of pools being built. Table 4:2 is supplied as a guide for spa whirlpools and vitality pools.

Health/Safety: The filtration plant room must be designed in accordance with published guidelines (e.g., Pool Water Treatment Advisory Group), and the water treatment plant arranged in accordance with good standard practice. Adequate provision has to be made for safe daily operator access and for effective and efficient ongoing service and maintenance of the entire system.

Work plinths may be required to provide access to all of the filtration and water treatment plant.

Lighting/Power: Adequate lighting and power supply outlets are necessary throughout plant and chemical rooms and should meet local/international requirements.

Ventilation/Temperature: The minimum number of air changes required in the plant room is four per hour. The temperature should not fall below 10° C or rise above 30° C.

¹ <http://floatforhealth.net/suedfeld.pdf>

² http://www.epsomsaltcouncil.org/articles/universal_health_institute_about_epsom_salt.pdf

³ Refer to the German DIN 51097 standard and aim for the classification “B” (least slippery); another respected standard to follow is the British Standard Pendulum Test BS 7976-2 and BS 13036-4

Pool Lighting

Halogen*

Currently being phased out in most countries because they are less energy efficient.

LED*

Offer longer life and varying color options; various size and styles of fitting available (flush, beveled, frosted glass, strip lighting, stainless steel bezel, etc.).

Fiber Optics

Provides lower level of illumination but offer unrivalled effects. Can create moods and sensations that cannot be achieved with most other lighting systems. Because fiber-optic lights contain no heat or electricity, they are well-suited for use in pools. They are also easier to maintain, as there is no “bulb” to replace; instead an illuminator or projector transmits the light through the fiber. This “remote light projector” can be located conveniently for bulb replacement.

*Halogen and LED lights must have an IP68 rating—this is the highest Ingress Protection rating and means they are protected against complete, continuous submersion in water.

Space

Pool (L x W x D)	Volume	Balance Tank (L x W x D)	Plant Room (L x W x D)	Area
3 m Dia	3 m ³	1.5 m x 1.0 m x 1.0 m	3.5 m x 3.0 m x 2.5 m	10.5 m ²
5.0 m x 4.0 m x 1.2 m	25 m ³	4.0 m x 1.2 m x 1.0 m	5.0 m x 2.5 m x 2.5 m	12.5 m ²
7.0 m x 6.0 m x 1.2 m	50 m ³	6.0 m x 1.5 m x 1.0 m	6.5 m x 4.5 m x 2.5 m	30.0 m ²

**Note: Maximum required height of full-ozone plants must be over 3 m.*



Hot Springs & Geothermal Mineral Waters

.....

This chapter covers the unique world of hot springs and geothermal mineral waters, including the health benefits of balneotherapy and was written in collaboration with the Global Wellness Institute’s Hot Springs Initiative, an international think tank dedicated to exploring the diverse values of geothermal waters for health, recreation, tourism and community.

.....

Hot springs and geothermal waters are enjoyed throughout the world and experiencing a renaissance. Pictured: Ojo Caliente Mineral Springs Resort & Spa, New Mexico.

Wellness travelers have sought the healing powers of hot springs since the beginning of time. The naturally warm, mineral-rich water flowing right out of the ground has soothed aches and pains for millennia, while the hypnotic and magical powers of hot springs have inspired healing lore and bathing rituals on every continent.

In fact, hot springs and geothermal mineral waters are experiencing a real renaissance as more modern bathers actively seek out the healing properties of balneotherapy (defined as the immersion in mineral water for health benefits). The Global Wellness Institute recently projected that the sector is on track to becoming a nearly \$65 billion wellness category by 2020 (up from \$51 billion in 2015).

What makes hot springs so magical is that no two are alike—each has a unique spectrum of minerals and other qualities. While all hot springs provide the familiar benefits of bathing, such as blood circulation

enhancement and relaxation, the greater power of hot springs is attributed to their minerals and other qualities including texture, alkalinity, odor and flavor. These qualities set hot springs apart from all other waters.

The water from hot springs—called “geothermal mineral water”—is typically formed as rain and snowmelt sinks through cracks and porosities in the ground to collect in underground permeable rock called “aquifers,” near volcanic or other hot underground geology. The hot water dissolves minerals from surrounding rock, and carries those minerals as it emerges on the surface as hot springs.

Natural hot springs are found as geysers, streams, seeps, bogs or steam vents. They occur in mountains, valleys, deserts, and even under polar ice sheets, lakes and oceans. Hot springs may be extremely hot or barely warm; some have strong odors while others are neutral. The water may be salty, bitter, sweet, hard or soft, nutritious for microbes and plants or relatively sterile, even corrosive or toxic to life.

In some cases, hot springs may be the only source of water in an area, while, in other cases, hot springs

will be found adjacent to streams, lakes or seawater. In addition to bathing and soaking, the water from hot springs can also be used for drinking, mind/body cleansing, heating buildings and even generating electricity. Some hot springs facilities combine all of those functions, making them one of the earth’s most sustainable and renewable resources.

Hot springs have inspired healing and bathing rituals in a cultures around the world, and today’s modern day wellness traveler can explore these unique destinations to refresh, revitalize and feel re-connected with the nurturing energies of these places.

Today, wellness travelers can seek out numerous types of hot springs—from rustic to luxurious or indigenous to modern urban. Visitors can soak for an hour or a day and can find hot spring facilities that suit their personal preferences—be it a contemplative spa with massage and yoga, family recreation with a water slide, or medical oversight with full lab analytics provided by doctors and sometimes funded by health insurance.

Regional, national and cultural preferences often guide the design of a hot spring facility, and the ways to use the water. However, regardless of whether it’s a water-



The natural hot springs at Germany’s Toskana Therme Bad Sulza are open for public use.

Ojo Caliente Mineral Springs Resort & Spa opened in 1868 and is the only hot springs in the world that touts four unique, sulfur-free mineral waters including iron, arsenic, soda and lithia.



slide recreational park, a spa, or a medical treatment facility—or just a trickle of hot water running into the ocean—it’s important to remember that a hot spring’s water has unique properties and potential health benefits regardless of how it’s used by the indigenous culture.

Hot Springs History

Modern history shows hot springs have been health and wellness destinations since the dawn of civilization around 5,000 years ago. Before that, our Paleolithic stone-age ancestors used hot springs for at least 40,000 years. Long before that, archaeological evidence reveals our Cro-Magnon and Neanderthal predecessors used hot springs sites for at least 200,000 years. The minerals and warmth provided year-round habitat for countless species of plants and animals through winters, ice ages and global catastrophes. Our predecessors relied on hot springs year-round for hunting and foraging, drinking, easing the body, and harvesting of minerals including salt.

Natural undeveloped hot springs still exist today, often in very remote wilderness or in areas that have challenging terrain and/or access. Adventurous hikers will often build basic pools and diverse systems that encourage air-cooling of the steamy water or devise a way to mix it with colder water, creating a comfortable soaking temperature.

Ancient Hot Springs and Modern Drilled Wells

For much of human history, naturally flowing hot springs were the only source of warm water in which to bathe. Early cultures used hand tools to dig small pools where they could submerge their bodies into the mysteriously warm water.

Today, well drilling technology and geologic science enables access to geothermal mineral water from deep aquifers, even several kilometers down, and in areas where natural hot springs have never freely flowed to the surface before.

Facilities built on drilled wells are commonly called “hot springs” even though a manmade well is not technically a “spring.” Some wells are able to produce water that flows to the surface by itself without a manual pump—this is called “artesian flow,” while other wells require pumping to lift the water to the surface. Springs will naturally flow to the surface without the aid of pumps, although, today, many modern hot springs are a hybrid of a spring and well because they have utilized drilled wells and pumps to enhance the water flow rate and increase pool bathing capacity.

For ease of understanding, the term “hot springs” is being used to define all geothermal mineral water



Hot springs create a natural social setting as seen here at Australia's Peninsula Hot Springs.

facilities built on either naturally occurring springs or drilled wells, or a combination of spring and well. Although all languages have words to describe both natural springs and wells, the term “hot springs” can be difficult to interpret in some languages and a more scientifically accurate term could be “geothermal mineral water.”

“Hot Springs” vs “Wells”

Springs

- Springs may have historic and pre-historic use by humans
- Springs generally have long history of biology and evolution of life
- Springs often have unique mineral deposits
- Ancient animal migration paths lead to some hot springs for salt or other minerals
- Spring aquifers may have elaborate underground channels emerging at springs

Wells

- Wells can provide geothermal mineral water in areas where no natural hot springs occur
- Wells rely on aquifers for their geothermal mineral water and risk depleting this precious water resource

Sustainable use of an aquifer depends on how long it takes rainwater to replenish the water that's pulled out. Some aquifers replenish very slowly or not at all; some

water is prehistoric, having been underground for thousands of years—similar to oil deposits that don't have access to the surface until a well is drilled, and are non-renewable. Most developed countries have regulations to ensure aquifers are not depleted.

Naturally flowing hot springs can be endangered through over pumping from aquifers for agriculture and urban use. Because aquifers are hidden deep underground, their complex flow and replenishment dynamics are often debated as politics collide with theoretical assumptions and available science. Regional water-laws often rule who can use the water, and for what purposes, especially during drought cycles. Hot springs and any unique species inhabiting them may be disadvantaged by the demands of industry and global population sprawl. For example, poorly understood microbiomes of hot springs have sometimes been destroyed before their potential medicinal benefits were understood. This highlights the ongoing issue of human need versus habitat and resource conservation.

Today's wellness travelers are usually conscious of their ecological footprint and the sustainability of resources. Abundant hot mineral water flowing right out of the earth is a sustainable resource. Many hot spring facilities will share what they know about their waters, from source-to-bathing.

Facilities, Culture and Etiquette

Natural hot springs are likely the very first type of hot-water bathing humans experienced, and are the first “spas” and original wellness destinations. Cultures throughout the ages have endowed hot springs with magical or spiritual powers for mystical awakening, sacramental drinking, anointing, physical healing and various religious rituals, including baptism.

Modern wellness travelers can enjoy hot springs in diverse locations and regions, all with unique experiences. Some facilities are designed into natural landscapes for an organic, natural experience, while others are fashioned on ancient and modern architecture. Some hot springs facilities offer a quiet, meditative atmosphere for self-reflection where contemplative inner focus is enabled. Some are more social or interactive; and others are for family recreation with waterslides, campgrounds and other complementary activities.

Medical hot springs are popular in countries where the water is part of a health cure and some treatments

are partially funded or fully funded by insurance companies or national health-care programs. They may offer full medical treatments prescribed by doctors that can include soaking, drinking and resting in hot springs waters and the surrounding environment.

To accommodate cultural, and often religious differences, some facilities offer designated areas or days for women, men, and families to bath separately. Some regions have modest clothing requirements relative and appropriate to their culture, while in other regions nudity or clothing-optional is the norm.

Certain regions have long-standing cultural traditions to follow or honor, while others are entirely informal and non-traditional. For the global wellness traveler, it is important to be aware of these traditions since bathing against cultural practice may be offensive or even illegal. It is therefore advised to adhere to the general culture and specific rules regarding bathing in each location.

In Europe, facilities are built to provide the best possible user experience as seen here at Germany's Toskana Therme Bad Orb.





Hot springs often provide a connection to local culture as seen at Peninsula Hot Springs, Australia.

Hot Springs Temperature Range

Some hot springs emerge from the ground at the perfect temperature for human bathing, which is often referred to by experts as the “Goldilocks Zone” because the water is considered “just right.” Others are either too hot or barely warm, so they must be cooled or heated by non-natural means for human use. Most often, hot springs come to the surface warmer than is comfortable for soaking and with too high a mineral content.

Water temperature is easily described as “hot, warm, tepid and cold.” The temperature of a baby’s bath is probably good for long-term soaking, while very hot or ice-cold water is only good for a quick dip. The word “hot” can mean many different degrees of temperature, which varies from culture to culture.

Human bodies tolerate a narrow range of water temperature for bathing. Generally, a comfortable range is between just below body temperature of 36° C (98° F) to a high of 41° C (106° F). Dangerously hot temperatures above 111° F or 43° C are typically too hot for most humans.

Unique Biodiversity and Species

Many unique species have evolved to inhabit certain springs, including aquatic plants, algae, fungi, fish, crustaceans, amphibians and insects. Some of these are extremophiles, meaning they tolerate extreme environments such as heat and high mineral concentrations. One classic example is the Julimes Pupfish that lives in a single Mexican hot springs location, with temperatures up to 45° C/114° F, along with a hot water snail and the various algae they eat. That temperature is far too hot for most humans to tolerate and very few organisms can survive in such hot water.

Green and blue-green colonies of single-celled photosynthetic plants thrive in mineral-rich waters and are often used as scrubs and masks for the body and skin. Muds, peats and surrounding soils are also used for body treatments, each with their own complex of microbiome species unique to that hot spring.

The genetic repertoire of these “hot spring specific species” offers a glimpse into how adaptation can occur within challenging concentrations of minerals.

Conservation of these species is critical to maintain their genetic diversity and future benefit to science and medicine. Encroaching developments and aquifer threats have led to closure of some hot springs to protect threatened species from extinction.

Hot Springs Sanitation

Like all public bathing waters, hot springs must be monitored for pathogens that could cause disease, such as *E. coli* and amoeba. Some facilities have sufficient water flow that no sanitizing chemicals are needed, and the pure water and minerals are ideal for bathing. Other facilities drain and clean the pools each day. Many others require sanitizing chemicals or treatments to maintain healthful water quality.

Although hot springs connoisseurs generally prefer non-sanitized hot springs, if required, most people agree that the chemicals are of less concern than illness caused by pathogens. Most “hot springs” facilities, spas and resorts are carefully managed for water quality and regional governments sometimes play a role in the sanitization management.

Wilderness hot springs sometimes have signs warning of various water-borne pathogens, aquatic insects or hazardous elements in the water, in addition to biting insects, spiders and mites in the surrounding vegetation of the oasis. Many species flourish at hot springs sites as they have for millions of years, so human newcomers must be alert in the quest for a good soak!

Before You Visit

Most facilities have excellent information about their waters—reviewing these is highly recommended. Be sure to inquire ahead of time regarding clothing and bathing protocols as some countries require specific clothing, may segregate women and men, while others will be clothing-optional or no clothing allowed. Some facilities encourage silence in pool areas to allow a meditative atmosphere, while others are more social and interactive.

Generally, it’s good etiquette to bathe or rinse before entering a public hot springs to keep lotions, oils, scents and sunscreen out of the shared water. The natural scent of the water adds to its healthful effects.

Reflexology walks are popular in and around hot springs and enable visitors to treat themselves to self-guided foot massage.



Taking the Cure

Nearly all hot springs facilities can provide health benefits derived from their unique mineral waters. Robust medical research, particularly in Europe, has proven the benefit of hot springs for specific ailments—often referred to as “cures.” Some cures are directly related to trace minerals or major concentrations of macro minerals, many of which are directly absorbed through the skin and then circulated through the body as they are incorporated into body tissues. Other cures are related to temperature, viscosity, alkalinity or other properties of the water.

Throughout history, people have reported “cures” of various ailments and a general boost in health and vitality from soaking in the waters. “Feeling better” is difficult to quantify scientifically, but it is evident that

humans throughout history have been feeling better from bathing in hot springs (balneotherapy). Many visitors to these waters believe them to be healing in an organic or spiritual way. Muds and algae from hot springs may be used as body scrubs or masque spa treatments, with benefits coming from the minerals and the unique microbial of species in the products.

Cold-water springs can also hold many of the properties found in geothermal mineral water as they are usually created by water that was very hot underground but has cooled on its way to the surface, retaining much of the dissolved mineral content. Health claims for cold water springs usually relate to drinking water, since it’s too cool for soaking. This water is often bottled and shipped globally.

Ancient humans generally relied on their senses and local lore to understand the health merits of a hot springs, the same process used to discern medicinal and nutritious plants throughout history. Modern technological analysis can supplement and validate the ancient lore while providing additional levels of knowledge that expand the story of water.

Of course, not all hot springs waters are healthful or nutritious—some may contain harmful levels of elements including arsenic or fluoride, while some minerals are beneficial only in small amounts and can be hazardous if consumed copiously. Many hot springs facilities provide detailed laboratory analysis of their water chemistry, along with recommendations for bathing and drinking.



Part of the fun—and benefits—of hot springs is rolling in the mud.

Types of Balneotherapy

Balneotherapy is the immersion in mineral water and/or peloid (geothermal mud/clay) for specific health benefits. It can be confused with hydrotherapy (the use of water for relaxation, pain relief and other treatments), but it's really a category of its own.

Maintaining a universal definition of 'balneotherapy' is important both for global research and the industry as a whole. Readers should note that the standardized definition of balneotherapy as agreed by the Global Wellness Institute's Hot Springs Initiative is "passive bathing in geothermal mineral spring waters with water content that is regarded as having unique health properties."

Various types of balneotherapy can be identified, including:

European Program: European balneotherapy programs are well documented and often studied. They usually consist of passive 20-minute bathing sessions two or three times a week over a course of three weeks.

Peloid Therapy: Refers to the use of mud/clay from geothermal environs.

Hot-cold Immersion: Hot springs bathing followed by cold plunge (or increasingly, ice immersion) is a common balneotherapy practice.

Inhalation: Refers to therapies that focus on inhalation of geothermal mineral spring water gases.

Watsu: Increasingly common treatment that utilizes the elements of Shiatsu while floating in hot spring waters.

Geothermal Water Exercise Programs: Unlike passive balneotherapy, these programs involve performing yoga and other stretches in geothermal waters.

Reflexology: Stone walks through geothermal mineral water.

Thermal Sound Therapy: Floation while music is played underwater.

Some hot springs emerge from the ground at the perfect temperature for human bathing, which is often referred to by experts as the "Goldilocks Zone" because the water is considered "just right."



Credit: Ojo Caliente Mineral Springs Resort & Spa

Classification Confusion

Unfortunately, there's no global agreement on hot springs classification. Instead, balneologists around the globe often create classifications of geothermal mineral springs in silos, with little or no collaboration. The lack of a unifying and globally-accepted classification system means that researchers—along with industry groups—continue to create their own.

For the purposes of this guide, we present a recent classification list created by the Hot Springs Australia group, which published a national classification protocol in 2018 that is based on the fundamentals of the more regulated definition of Japanese 'onsens' (the term for the popular hot springs and bathing experiences found all over Japan).

Australian Hot Springs Classification

Hot springs are classified according to four criteria: well temperature, pH, osmotic pressure and type of spring.

1: Well Temperature

Cold Spring: up to 20° C

Warm Spring: 25° C to 34° C

Hot Spring: 34° C to 42° C

Extra Hot Spring: over 42° C

2: PH

The pH of the water has a large effect on how the water feels. The more alkaline the baths, the softer and soapier the water feels. Alkaline baths are thought to be good for the skin and are also called “beauty springs”. Acidic baths will, conversely, feel much harder or firmer on the body. Both sensations are enjoyable and a matter of personal preference.

Acidic: pH of 3 or lower

Weak Acidic: pH of 3 to 6

Neutral: pH of 6 to 7.5

Weak Alkaline: pH of 7.5 to 8.5

Alkaline: pH of 8.5 or greater

3: Osmotic Pressure

This is the total weight of the dissolved solids in a given amount of the spring water and the water's ability to hold those minerals in suspension. The difference is often visible as spring water that contains a high percentage of dissolved solids will typically be opaque.

Low: 8g/kg of dissolved solids or lower and a freezing point of -0.55° C or higher

Isotonic: 8g/kg to 10g/kg of dissolved solids with a freezing point of -0.55° C to -0.58° C

High: 10g/kg or higher and a freezing point of at least -0.58° C

4: Hot Spring Types (Based On Japan's "onsen" classification.)

Simple Hot Spring: Water that does not contain enough minerals to be classified in detail but are still considered onsen.

- Simple hot spring
- Simple alkaline hot spring

Chloride Springs: The most common type of hot spring in Japan. The salt content helps clean the body of sweat while helping the body retain heat.

- Sodium chloride spring
- Strong sodium chloride spring
- Sodium chloride carbonated spring
- Sodium chloride sulphate spring
- Sodium and calcium chloride carbonated spring

Carbonated Springs: These may have a softening effect on your skin and leave the body feeling refreshed and cool after bathing.

- Sodium and calcium bicarbonate spring
- Calcium and sodium bicarbonate chloride spring
- Calcium and sodium bicarbonate sulphate spring

Sulfuric Acid Springs: These springs help reduce pain, combat liver disease and constipation. The calcium type also has a calming effect. The magnesium helps lower blood pressure.

- Calcium sulphate spring
- Sodium sulphate chloride spring
- Magnesium sulphate spring

Iron springs: The iron in the spring is absorbed by the water and helps in blood production. Although these springs are clear when they emerge from the earth, the iron in them will oxidize and turn a brownish color.

- Iron carbonated spring
- Acidic iron sulfuric acid spring

Aluminum Springs: These springs may have disinfectant properties and benefit some skin diseases.

- Aluminum and iron sulphate spring

Radioactive Springs: The radon is absorbed into the body and breathed in as the gas escapes from the water. The use of radioactivity for positive medical effects is greatly debated but has been done for many years. Radon caves where people go to breath in the gas for therapeutic reasons are still in operation in parts of North America. One should use their own judgment when deciding to expose themselves to radioactivity like this.

- Simple radioactive spring
- Simple weak radioactive spring



Underground vapor cave at The Historic Wiesbaden Hot Springs Spa & Lodgings in Ouray.

Research and Evidence

Geothermal mineral water has long fascinated both scientists and physicians. Herodotus, one of our earliest historians (born around 484 BC) was the first to describe the use of springs and spas for the treatment of various diseases, prescribing a 21-day limit to therapy duration, while Hippocrates, Asclepieades, Pliny the Elder and Galen all advocated bathing for a range of conditions in different types of water. In addition, the Austrian physician Caspar Schober wrote a treatise in the early 16th century that described a method for analyzing the German Gastein hot springs to examine their therapeutic effects.

In the 1900s, research into hot springs explored their benefits for a wide range of clinical conditions. There's a 1940's paper on the treatment of venereal diseases; research on the benefits of thermal springs treatment for polio survivors, including Franklin D. Roosevelt's rehabilitation at Warm Springs, Georgia; and post WWII research hypothesizing a potential cure for deafness through vapor from the Brazilian Pocos de Caldas hot springs. In this century, studies have

aimed to explain the functions of the various specific mineral elements in balneotherapy—such as sulfur, magnesium or radon—linking individual minerals to the treatment of particular diseases, like sulfurous-rich water and recurrent upper respiratory tract infections.¹

A very recent example of balneotherapy's effectiveness comes from research published in *Clinical Rheumatology* (May 2018), which studied 100 patients with fibromyalgia syndrome over a 15-day balneotherapy cycle at Levico Terme Spa Center located in Trento, Italy. Half the patients participated in passive balneotherapy in highly mineralized sulfate water, while the other half bathed in plain tap water. The 50 patients that were randomly selected for balneotherapy treatment showed significant improvements in pain and other symptoms—even when measured at two weeks, three months and six months post treatment—while the 50 patients in the control group showed no significant changes.

Additional Resources on Health Benefits of Balneotherapy

Stress Relief: A 2014 Austrian study found balneotherapy more beneficial for stress relief, measured by both participants' subjective reports and a decrease in salivary cortisol shown in lab results. (Matzer, Nagele et al. 2014)

<https://www.karger.com/Article/Abstract/360966>

Immune Response: A 2016 Turkish study showed the immune system adapts to bathing heat stress with an increase in heat shock protein 70. (Uzunoglu, 2016 #174)

<https://www.scopus.com>

Low Back Pain: Among the many studies in this area, 2012 Hungarian research showed beneficial effects across a range of measures of balneotherapy in thermal mineral versus bathing in heated tap water. (Tefner, 2012 #255)

<https://www.ncbi.nlm.nih.gov/pmc/articles/PMC3955132/>

Mental Health: A relatively recent field of interest, researchers appear increasingly active in the effects of hot springs bathing for those with depression, anxiety, stress, insomnia and other mental health conditions. Increasingly we see that within studies into balneotherapy effects for psoriasis, fibromyalgia, arthritis and other chronic pain the mental health effects are measured through Quality of Life (QoL) indices.

<https://www.ncbi.nlm.nih.gov/pubmed/28936572>

Fibromyalgia: This is a trending focus within balneotherapy research, with 22 studies published in the past 10 years. Chronic pain, sleep deprivation and depression are often symptoms of fibromyalgia, balneotherapy has shown beneficial impacts for all. The main drive behind these studies seems to be the interest in long-term programs of non-pharmacological treatment for people with chronic pain.

<https://www.ncbi.nlm.nih.gov/pubmed/29730741>

Sleep and Quality of Life: In the past decade, hot springs research has expanded to include outcomes such as sleep and quality of life (QoL). For example, a recent study surveyed hot spring users perception of how hot springs influenced mood, sleep, anxiety and depression in healthy older people (Latorre-Román, Rentero-Blanco et al. 2015).

<https://www.ncbi.nlm.nih.gov/pubmed/25515521>

Quality of life has featured in studies over the past decade, such as a survey of 334 Japanese civil servants (Sekine, Nasermoddeli et al. 2006). This study employed elements of the SF-36 QoL scale, finding better results with the frequency of hot springs use in both men and women.

<https://academic.oup.com/jpubhealth/article/28/1/63/1553669>

Connection with Nature: While the core focus of most balneotherapy studies has been on minerals in geothermal water and their effect on musculoskeletal conditions, some researchers note that we should not discount the effects of being out in nature at hot spring resorts.

One such study was the 2011 research into mechanisms of action of spa therapies in rheumatic diseases, where the authors note that non-specific factors may also contribute to the beneficial effects observed after spa therapy, including effects on cardiovascular risk factors, and changes in the environment, pleasant surroundings and the absence of work duties. (Fioravanti, Cantarini et al. 2011)

<https://www.ncbi.nlm.nih.gov/pubmed/21120502>

The Chemistry of Mineral Water

Hydrogen sulfide is the chemical compound that is known for its “rotten egg” smell, and its role as an analgesic has received the most scientific attention, including a 2013 study that appeared in the *European Journal of Inflammation*² and another in the same year entitled “Sulphurous thermal water increases the release of the anti-inflammatory cytokine IL-10 and modulates antioxidant enzyme activity.”³

Magnesium in geothermal water has been attributed to successfully treating dermatological conditions,⁴ while radon-enriched hot springs are thought by some to increase the body’s resistance to cancer by elevating p53 protein levels.⁵

The effects of balneotherapy on chronic pain has been studied extensively. A 2015 review of 27 studies, concluded there is a high level of evidence that spa interventions reduce chronic pain and analgesic consumption and improve function and quality of life,

in chronic low back pain and knee osteoarthritis cases.

Another review found “100% positive outcomes for clinical improvement, pain alleviation and improved quality of life,” a finding that was backed five years later by another systematic review which concluded that balneotherapy “is an effective remedy for lower back pain, as well as knee and hand osteoarthritis.”

¹ Salami, A., M. Dellepiane, B. Crippa, F. Mora, L. Guastini, B. Jankowska and R. Mora (2008). “Sulphurous water inhalations in the prophylaxis of recurrent upper respiratory tract infections.” *International Journal of Pediatric Otorhinolaryngology* 72(11): 1717-1722.

² Carubbi, C., G. Gobbi, G. Bucci, M. Gesi, M. Vitale and P. Mirandola (2013). “Skin, inflammation and sulfurous waters: What is known, what is believed.” *European Journal of Inflammation* 11(3): 591-599.

³ <https://www.ncbi.nlm.nih.gov/pubmed/24067460>

⁴ Proksch, E., H. P. Nissen, M. Bremgartner and C. Urquhart (2005). “Bathing in a magnesium-rich Dead Sea salt solution improves skin barrier function, enhances skin hydration, and reduces inflammation in atopic dry skin.” *International Journal of Dermatology* 44(2): 151-157.

⁵ Yamaoka, K., F. Mitsunobu, S. Kojima, M. Shibakura, T. Kataoka, K. Hanamoto and Y. Tanizaki (2005). “The elevation of p53 protein level and SOD activity in the resident blood of the Misasa radon hot spring district.” *J Radiat Res* 46(1): 21-24.



Why Do Some Hot Springs Smell?

Some geothermal mineral waters contain ingredients with strong characteristic tastes and odors including: hydrogen sulfide gas (the classic “rotten egg” smell), iron, salt, magnesium, copper and other compounds. These odors and flavors relate to the unique composition of each source. Certain microbial species may also contribute to distinct odors or flavors, especially as they decompose.

As with wine and plant essence aficionados, a hot springs’ connoisseur may be able to identify subtle odor and essences in water samples and know its mineral type. Some scents or flavors may not taste good, and yet provide health benefits, as with plant alkaloids. The taste or smell may or may not be associated with specific health benefits.



Hot springs in natural surroundings let bathers get in touch with nature, while experiencing the wellness benefits of their unique water properties.

Hot Springs Terminology

Algae: informal term for a large and diverse group of simple organisms of aquatic or moist habitats

Aquifer: an underground layer of water bearing permeable rock

Balneotherapy: the practice of immersing in mineral water or mineral-laden mud

Extremophiles: an organism that thrives in physically or geochemically extreme environments

Gas: a substance possessing perfect molecular mobility and the property of indefinite expansion, as opposed to a solid or liquid

Geothermal: energy, generated and stored in the Earth that determines the temperature of matter

Geothermal Mineral Water: water flowing from hot springs

Goldilocks Zone: the natural, ideal hot springs temperature

Ground Source Loop Heat Exchange: drilling a dry well deep enough to access the natural underground heat of the Earth, bringing that heat to the surface with fluids and transferring the heat to municipal water

Halophyte: a saline-tolerant plant species

Hot Springs: geothermal mineral water facilities whether they're naturally occurring hot springs or

modern drilled wells, or a combination of both spring and well

Hydrology: the scientific study of the movement, distribution, and quality of water on Earth and other planets

Microbiomes: the microorganisms in a particular environment

Mineral: a mineral is a naturally occurring substance that is solid and inorganic and has an ordered atomic structure

Mud: wet, soft earth or earthy matter occurring in or around hot springs.

Peloid: mud, or clay used therapeutically, as part of balneotherapy, or therapeutic bathing. Peloids consist of humus and minerals formed over many years by geological and biological, chemical and physical processes

Peat: brown soil-like material characteristic of boggy, acid ground, consisting of partly decomposed vegetable matter

Primordial: ancient, prehistoric, from the beginning.

Replenish Rate: the rate at which an aquifer's water is naturally replaced



Construction Materials and Building Services

.....

This chapter covers the major elements in the engineering and management of a hydrothermal spa. It's designed to give readers a closer look at the “behind-the-scenes” operations that bring a spa design to a working reality, including the ventilation, drainage, electrical services and lighting. The choices made in building services also play a key role in the overall environmental impact of a building—something that is relevant both in domestic and commercial builds of hydrothermal areas.

.....

A calm and confident front desk is the result of a well thought out hydrothermal build that not only appears inviting but also operates so smoothly that guests are unaware of anything going on behind the scenes.

Please note, this chapter is meant as a general guideline and it's important to work with specialists who have local knowledge on the standards and codes to follow.

Before getting into the technical, behind-the-scenes working of a hydrothermal spa and all the specific considerations that must be made when embarking on one of these complex builds, we are providing readers with an inside look at how these builds come together from beginning to end. The pictorial on the following pages clearly illustrates how new advances in building and construction—specifically, factory-controlled prefabrication and on-site assemblage—are shaping the future of hydrothermal areas. It shows just how much of the work can be accomplished offsite (a big bonus if the facility is already in use) by pre-configuring hydrothermal areas in environmentally-friendly, easy-to-customize hard foam support material that can then be shipped and assembled onsite.



Taking a concept design and turning it into a fully working hydrothermal area requires numerous steps. This is the end result of an extensive hydrothermal shower area for Fitness Palace in St. Petersburg, Russia.

Stages of a Hydrothermal Spa Build

As discussed in Chapter 3, a lot of resources go into the planning and design of a hydrothermal area. Once the concept and general design parameters are in place, it's time to get to work building!

So how do the concepts and experiences that an entire team has agreed upon make it from paper to reality?

The architectural concept drawings on the adjoining page were created for Fitness Palace, a high-end fitness studio located in St. Petersburg, Russia that wanted to completely refurbish its male and female shower areas with only 30 days of downtime. A St. Petersburg consultancy, LV Studio, led the design of the area.

As is common in most of today's hydrothermal builds, the Fitness Palace project was constructed of prefabricated hard foam—which is not only environmentally friendly and ideal for a moisture-rich environment but also enabled much of the work to take place off premises so that the building could operate as normal for as long as possible.

1: Idea and Planning

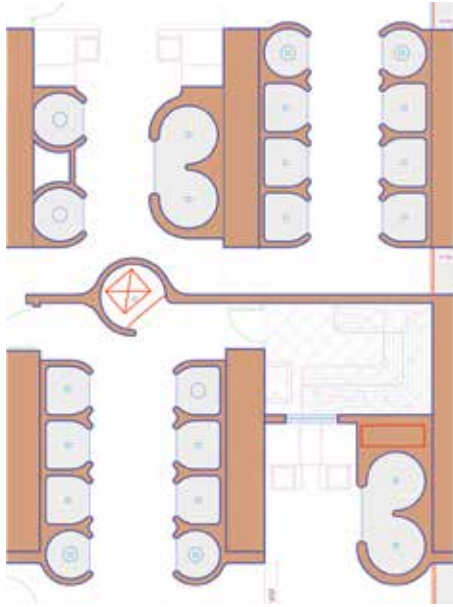

Plan shows separate male and female shower complexes featuring multiple shower experiences, foot spas and a sauna.

2: Technical Drawings

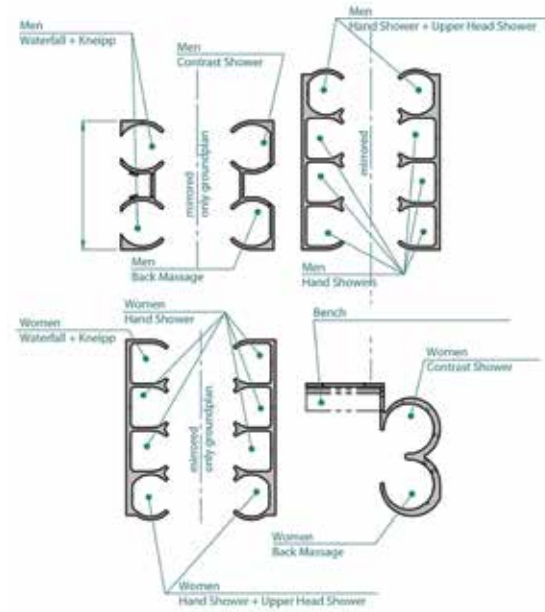

The labeled technical drawing indicates the intended functions of each area.

3: 3-D Drawings

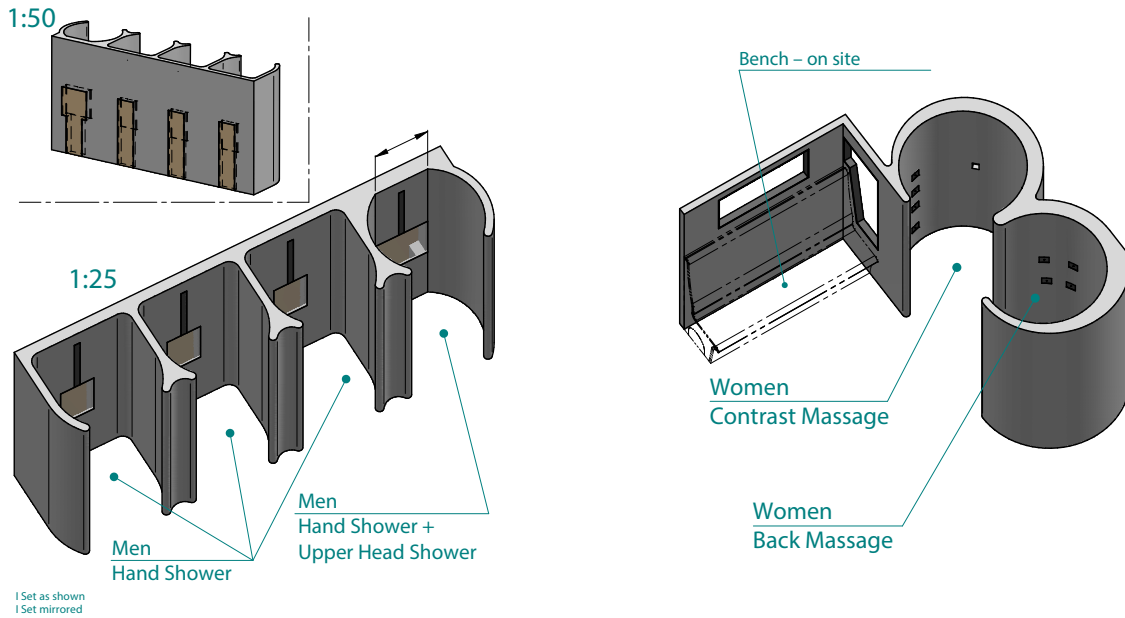

3D drawings are then created showing the scope of the prefabricated shower complex that will be manufactured in hard foam and will be the base for the completely waterproof, finished product.

4: Assembly



While still in the factory, boards are routed for pipes, shower valves and conduits to carry wiring for buttons and lighting. Pre-plumbing even takes place in the factory.



The pipes and conduits are stubbed out at ceiling height ready for site connection by the various on-site subcontractors and engineers.

5: Assembly: Dry Build



Once completed in the factory, all components are dry built before shipping and labeled for easy on-site assembly.



Pre-assembling in the factory eliminates any unwanted surprises at the building site.

6: Construction



Once on site, the installation commences and all the components are set out and glued together.



Services are connected, with convenient niches between the showers that enable access panels.

6: Construction (Continued)



Work is easily coordinated with local contractors, such as drywall and tiling contractors. Electrical heating cables can be seen buried in the insulated construction of the bench (right).



This is transformed...



Into this!

All Images Courtesy: Lux Elements GmbH

Ventilation and Climate Control

Typical Steam Room Equipment and Recommendations

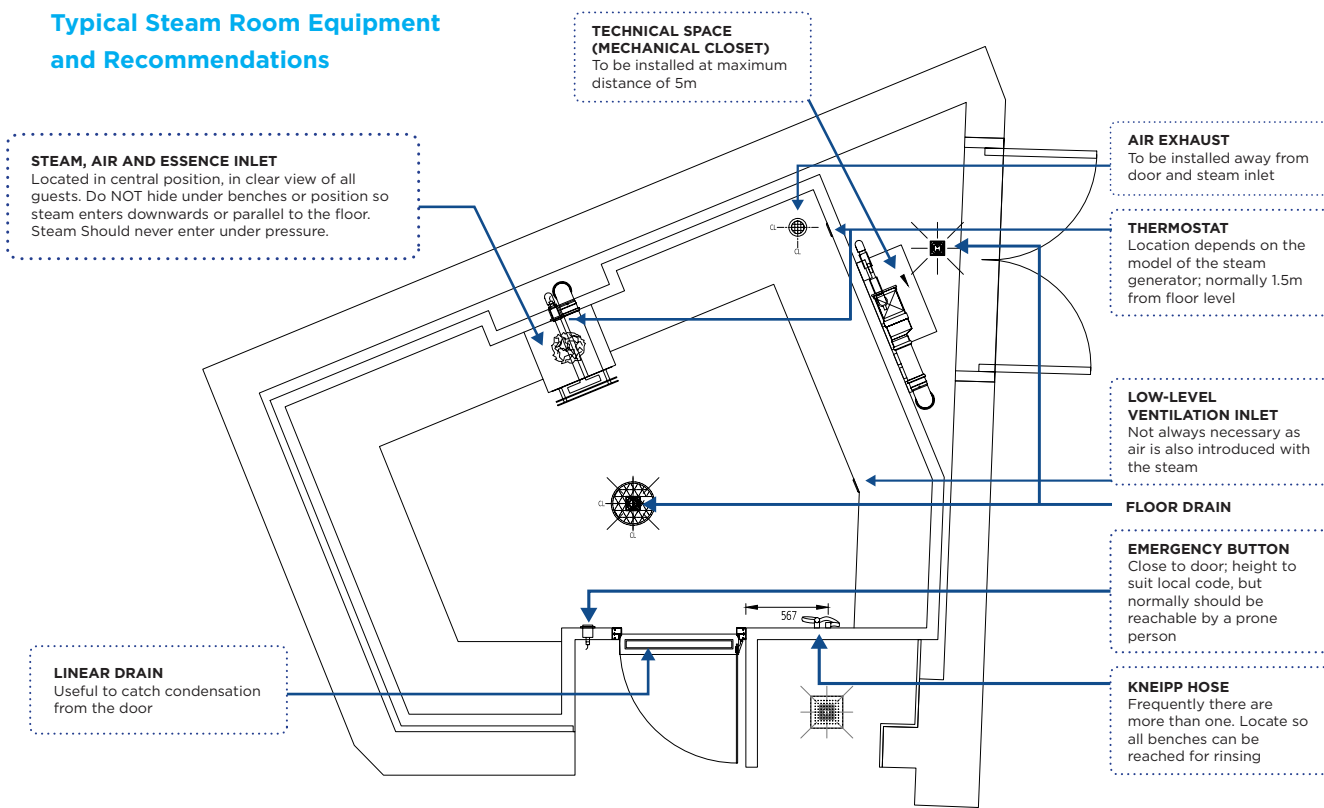

Regardless of the type of thermal room or cabin—sauna, steam bath, hamam, relaxation room, etc.—proper ventilation and climate control are crucial to the bathers’ comfort and health and significantly impact the effectiveness of the thermal room. A heating, ventilation, air conditioning (HVAC) contractor must be engaged for this purpose and will work closely with the mechanical and electrical (M&E) consultant.

Key to proper ventilation is the supply of oxygen to the room—this is vital in artificially heated environments. Low oxygen levels will result in bathers feeling or even becoming truly unwell, including fainting or worse. In addition, proper ventilation will promote drying of the rooms. Mold, fungus and bacteria spores easily grow in warm, moist environments so correctly engineered ventilation will aid in the drying out of the cabins and will minimize the health risks associated with these microorganisms.

Importantly, proper ventilation is what keeps the rooms at optimum bathing temperatures and ensures

correct levels of humidity are produced for the maximum benefit (especially important in a steam room). When a cabin is not run at the correct temperature or does not provide the right humidity level, the experience will not meet bathers’ expectations.

The materials used to build cabins have a significant effect on the efficiency of the room and how easy or difficult it is to maintain the correct climate. If traditional building materials like concrete, blocks or drywall are used, there will be a greater likelihood that the steam generation will not function correctly. The use of efficient building materials, such as a coated foam board that provides maximum waterproofing and thermal insulation, increases the effectiveness of the steam generator. Even then, there will be a level of radiant heat reflected back into the room from the wall and floor finishes, which will usually be some form of tile or stone that will require ventilation.

If not ventilated properly, radiant heat can upset the temperature/steam balance. Because steam rooms

and other humid/wet cabins require varying levels of humidity to be artificially created via steam generators, they will be relying on temperature probes or sensors (hygrometers) to activate the steam. If the sensors can't detect the correct temperature because there's too much heat in the room or they are incorrectly placed (e.g., too high)—an issue frequently caused by overheating the walls and benches or using inferior construction materials that absorb and emit too much heat—then the temperature/steam balance becomes unsettled, and the room is not able to function as it should.

The placement of temperature sensors needs particular attention. They are usually located approximately 1.5 m from the floor (which is the approximate height of a person's head—and the most sensitive part of the body—when sitting on a bench), and, because the sensors penetrate the walls, they are susceptible to high levels of heat being radiated from the structure of the walls.

Professional steam generators can operate inlet and exhaust fans automatically to maintain and regulate the optimum cabin climate. For example, an exhaust fan will not be switched on until the cabin reaches



Common Mistakes

- Not making provision for increased air distribution around hotter temperature pools (e.g., vitality pools) and treatment plant rooms. HVAC consultant must pay close attention to the temperatures of the pools.
- Not having correct water pressure and flow rate to operate experience showers, jet showers, Vichy showers, etc.
- Not choosing a steam generator based on the quality of the local water—hard water or soft water require different systems
- Not considering that materials used for ventilation ducts have to be non-corrosive
- Lacking proper air exchange in steam rooms. Extraction fans should have the capacity to exchange the room volume at a rate of 4-6 times per hour.
- Failing to place temperature sensors and other cabling within an electrical conduit for easy maintenance.

When planning a thermal room, it's imperative to include cut-outs and slots for electrical conduits and cabin control units. Without conduits, it's nearly impossible to perform any required maintenance without damaging the walls. Image shows prefabricated walls with conduits in place.



the desired temperature. It will then extract the condensation heat accumulation until the steam bath temperature drops below the set point, which switches the generator on again.

An overrun program (drying program) keeps inlet and outlet fans running for a period after the unit is switched into standby mode. This ensures complete evacuation of the steam and assists in cooling and drying out the cabin.

Proper ventilation in the pool area helps minimize evaporation and controls condensation. In addition, it removes chlorine smells and other contaminants from the air and creates a comfortable environment for bathers, staff and spectators. Pool areas are generally kept between 24° C to 28° C, but this also depends on the time of year, the temperatures of the pools in the area, etc. Getting this right is critical to bather comfort, and it is imperative that the HVAC specialist and wet area specialist work together to calculate the fresh air and air changes required, as well as the temperature

that needs to be maintained in this area.

Because of the higher operating temperatures in the pool area, evaporation is a key consideration when planning climate control and ventilation. Some general evaporation principles to be aware of:

- Larger water surfaces result in a greater evaporation and condensation. *Use a pool cover where possible.*
- Higher water temperature = higher rate of evaporation
- Lower indoor air temperature = higher rate of evaporation
- Lower indoor relative humidity = higher rate of evaporation
- Greater air movement = higher rate of evaporation

Note that there is a theory that condensation can be significantly minimized if the air temperature is kept 1° C to 2° C higher than that of the temperature of the pool. However, this does NOT work for vitality pools which are usually kept at 36° C. The air temperature will become far too hot if it's raised even just 1° higher.

Thermal Cabin Ventilation

Typical Duct and Air Valve Materials

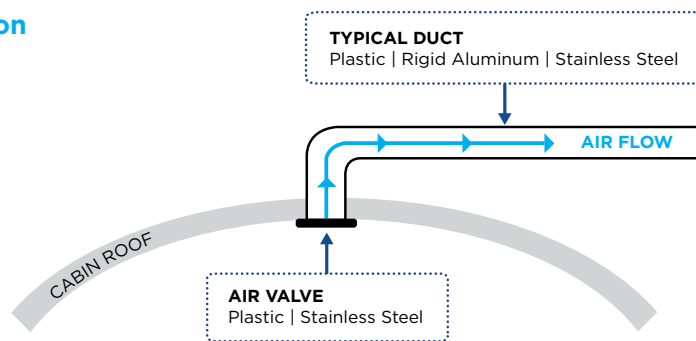

Extracting Air at High Level Using Variable Speed Fans (Preferred Method)

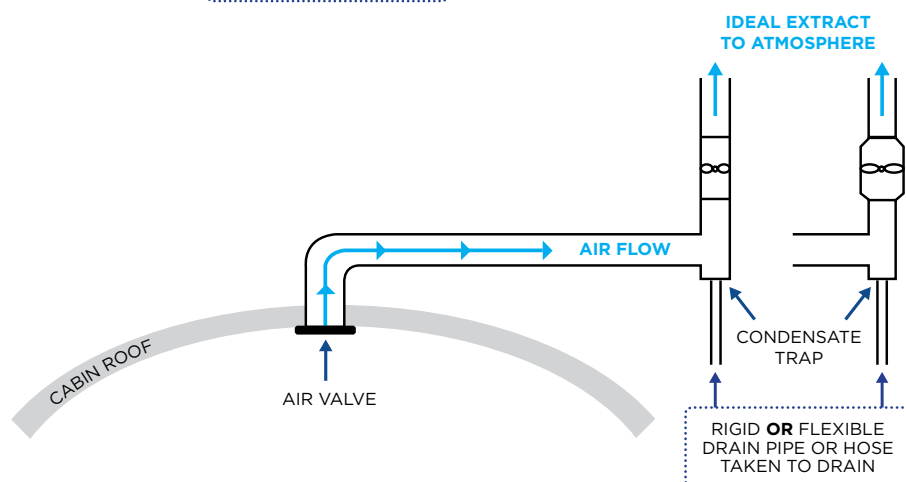

Air and Heat Extraction Tips

Wet area specialists are well-versed in accepted standards of air and heat extraction and can advise the HVAC consultant. It's important to follow these general guidelines:

- Exhaust ductwork must be made of a non-corrosive material—plastic, aluminum or stainless steel, depending on local building department regulations and codes. Moist air, often mixed with the essence of essential oils, can be very corrosive.
- Exhaust ducting must be smooth, not flexible, to avoid condensation.
- Exhaust ducting must always fall in the direction of a condensate drain point, which should be at the lowest point in the ductwork. If necessary, more than one drain point should be provided. It is vital that all risks of pooling or lying water be removed to prevent the incubation of Legionella (the bacteria that causes legionnaire's disease, a severe form of pneumonia).
- Correct balancing of the ventilation system requires each cabin to have its own inlet and exhaust fans.
- If individual fans are not used, an electrical or manually operated volume-control damper should be installed within the duct.
- Fans should provide four to six air changes per hour and have variable speed controllers to balance airflow and ensure a slight negative air pressure in the room.
- Inlet and exhaust ducts in rooms terminate in plastic or stainless steel grilles or air valves—these are NOT intended to replace fans or volume-control dampers.
- Avoid painted or coated aluminum grilles, as the coating invariably peels off.
- Fans should be installed in a vertical section of the duct wherever possible.
- If fan is of a larger diameter than the duct, it is mandatory that it is fitted in a vertical section of the duct to avoid water condensing in the fan housing.

Land Vs. Maritime Construction

Recognizing the huge trend towards putting spa facilities on boats and cruise ships, here are some considerations to make when building wet areas that will be at sea:

- Building standards/codes for ships are set by IMO-International Maritime Organization, not other standards mentioned in this handbook
- Fire safety and smoke minimization is critical - far more so than for land-based projects
- Thermal cabins must be constructed in aluminum sheet - using the traditional "dry wall" system of metal framing, but replacing gypsum board with a single aluminum sheet on the outside, fiberglass insulation in the core and a twin-wall aluminum sheet on the inside
- Walls must then be sealed and waterproofed with resin compound and bondage

- Condensate traps and drains for thermal rooms are not standard pieces of equipment available "off the shelf" from HVAC equipment suppliers—the HVAC contractor should have a specialist ductwork fabricator manufacture suitable components.

Note: Local and/or national building codes also must be considered.

It is important to balance the ventilation system to ensure a slight negative pressure to minimize the loss of steam/climate. This will not, however, be able to completely stop steam being sucked out of the cabin, so it is vitally important that the HVAC contractor installs an exhaust point directly above the door, to the exterior of the cabin. This positioning is ideal because an exhaust point further away will draw the escaping hot, humid air along the ceiling and, the further it is drawn, the more it will condense and cause drips. This often causes considerable damage to ceilings, which will not have been constructed in materials or with finishes to withstand constant exposure to moisture.

Electrical Services

In today's hydrothermal spas, the electrical load required for all the specialist equipment is extensive. For example, the steam generator and sauna heater are typically electrically driven, as are the mood lighting systems featured in thermal cabins and pools, just to name a few. Electrical planning, therefore, forms an important part of the overall planning of a wet spa, especially when you also consider the in-room extras like electronically adjusted massage tables and specialist treatment devices. The amount of ampere or kilowatts required and the distribution of that power require consultation between an M&E consultant and a wet area specialist.

Of course, if the building has limited access to electricity for any reason (such as electricity is cost-prohibitive or the location is far from the power source), understanding and planning for the electrics at the earliest stages is even more crucial. If electricity is in short supply, there are alternatives that can be considered, such as heating pools using a heat exchanger or using traditional wood burning stoves in a sauna.

Because thermal rooms feature the use of heat and water, safety requirements are paramount when it comes to the electrical components and fittings. They need to be protected from both these elements through

the use of waterproofing, correct heat shielding and the selection of fittings, as required by the needs of the installation.

When placing electrical socket outlets in wet treatment rooms, they should be in housings or mounting systems that are in compliance with national electrical codes. When sourcing the treatment equipment that will be using these sockets, ensure they can be locally transformed to 12/24V to minimize risk.

All wet-area electrical outlets should be protected by residual current devices that are designed to trip quickly if any water ingress causes leakage of current to earth/ground. It is important to earth/ground-metal-framed equipment; furniture and plumbing must also be earth/ground-bonded in wet areas. This also applies to metal door frames.

Often omitted in design are power sockets required for cleaning equipment. These, ideally, should be placed outside the room or within built-in cabinetry in the room. In a multi-function room where multiple treatments require varying electrical equipment, the equipment should be housed in cabinetry and the sockets enclosed within the cabinets.

Some countries have restrictions on electrical sockets being at a set distance, often 2.0 m, from a water

Calculating Electrical Costs of Spa Area

1. Calculating the electrical costs of a spa area is easily done if the cost per kilowatt hour (kWh) is known.
2. Add up the total wattage (in kW) of the equipment in spa, e.g. sauna (12kW), steam room (18kW), hamam (12kW), pool (15kW) and hot tub (18kW)
3. In this example, the total load is 75kW
4. Multiply total load by operating hours per day and then the operating days per month: 75 x 16 hours/day x 30 days per month = 36,000 kilowatt hours (kWh) per month.
5. Multiply 36,000 kWh by the energy provider's rate (USD \$.018 in this example). Therefore, electrical operating costs will be \$6,480 per month or \$216 per day or \$13.50 per hour.



Fragrance pumps can power multiple aromas.

source. This can be particularly restrictive if plug-in equipment is required for treatment preparations, so care should be taken in planning the preparation area to ensure a cabinet-mounted socket is within reach.

Electrical equipment within thermal rooms, e.g., sauna stoves, lamps and lighting, is normally manufactured, tested and certificated as safe for use in the environment in which it is to be used. This is why sourcing equipment from specialist manufacturers is essential. In many countries, safety codes differ between commercial and residential properties so care should be taken that, in all instances, only professional-duty products are used.

As the electrical services are a major installation, the relevant circuit boxes, breakers and other system components need to be installed and maintained. All electrical work should be carried out by qualified persons and in accordance with local regulations and permit requirements.

Drainage

This is one of the key components of a successful wet-room installation, as it has implications for maintenance, cleaning, health and safety. The drainage system is in place to remove water from all sources (taps, shower heads, hoses, condensation, etc.) and will also facilitate the cleaning and washing down of an area. The quantity and positioning of waste drains is key to efficient drainage, as are the quality of fittings—which

Electrical Equipment Found in Wet Treatment and Thermal Rooms, Includes:

- Aromatization/fragrance blower
- Fragrance pump (pump for single/multiple fragrances)
- Brine solution pump (pump for sterile brine solution spray)
- Bubbling system (for foot baths)
- Foam generator (for hamam massage)
- Infrared heat lamps
- Lighting—ceiling LEDs, ceiling lights over treatment tables, wall sconces, under-bench strip lights and control units for light programs, including transformers
- MP3 player
- Speakers
- Steam generator
- Steam shower
- Sauna heater
- Control panels
- Panic/emergency button connected to an external alarm
- Heating systems for floors, benches in tiled rooms

can corrode quickly if sufficiently robust materials are not used.

Multiple drains may be required depending on the floor area and the equipment used—for example, steam generators will require separate drainage from the waste outlet. While foot spa basins that run automatic fill and emptying programs will need an overflow outlet in case of a drain valve failure.

Drain systems should offer a high drainage capacity—not less than 42 liters/min in a normal hydrothermal room installation, and higher (minimum 60 liters/min) for other specific applications, such as experience showers. There should be an adequate fall to each drain (usually 1:100), and care should be taken to minimize the potential for user accidents (slip and trip). Typically, slip-resistant floor surfaces are required.

Drainage grids/grates may be lockable to both prevent vandalism and ensure large objects are not evacuated into the system. In addition, traps are required on drains to prevent smells from lingering inside the piping, and drainage systems can also be connected to recycling systems to minimize waste/water pollution and improve utility efficiencies.

Heating and Cooling Services

Given the importance of hot and cold experiences in a hydrothermal spa, special attention must be paid to creating water and air that is the correct temperature. This can be especially challenging in regions where cold water is not available—such as in the heat of the Middle East.

Many of the features in a hydrothermal spa require cooling down versus heating. For example, snow rooms, ice fountains, cold plunge pools and spray-mist experience showers need to be chilled and cool. Depending on the location, chilled and/or cold water

will either be provided by the mains or created on site. Conversely, hydrotherapy pools, onsen pools, tropical rain-shower experiences and many others are warm experiences and require heated water or air. The alternate hot-and-cool experience found in a Kneipp walk or Kneipp basin is an example of an experience that must supply both hot and chilled water at a specified temperature, in order to deliver the correct Kneipp experience.

In the Middle East and parts of Asia and Asia-Pacific, cold water is available via the mains, but it isn't usually "cold" by the time it reaches its destination. Chilled water may be provided instead, but this water is usually contaminated with chemicals and, therefore, unusable. Experts are required to solve this dilemma, and they may introduce heat exchangers to cool down the "cold" water from the taps for use in fog showers, cold plunge pools, etc.

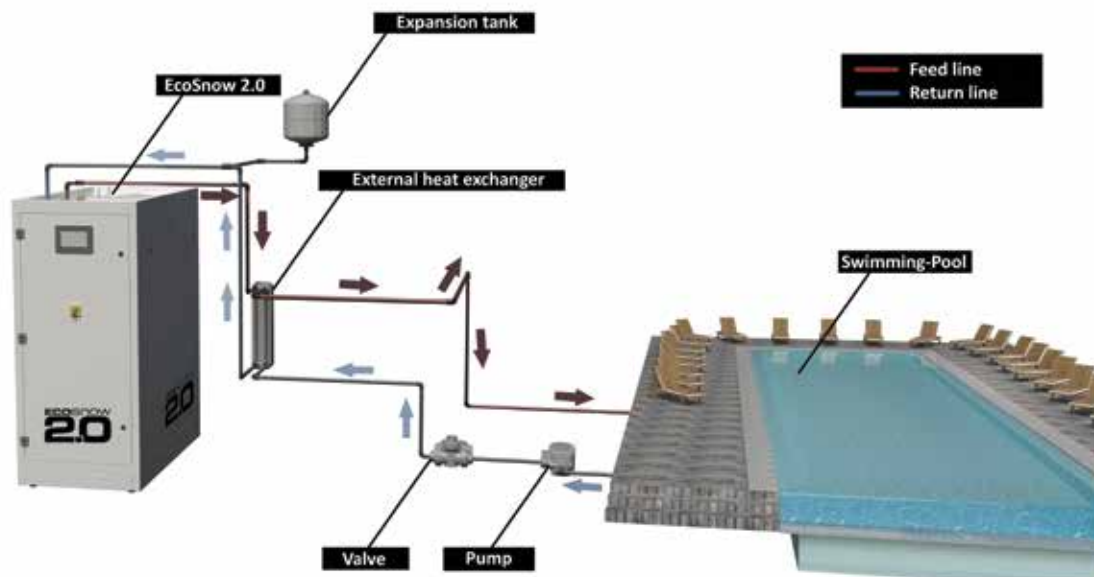

This diagram illustrates the symbiotic relationship between heat and cold in a modern spa. The water required for snowmaking comes from the pool and the heat generated by the snowmaking is funneled back into the swimming pool.



An example of a “loft” style ceiling.



A flat ceiling in a steam room can work perfectly well as long as it is correctly designed, insulated and finished.

Ceiling Design and Construction

There is frequent debate and discussion on the topic of ceiling design in thermal cabins due to their unique environment.

Some of the common questions raised, include:

What is the ideal height for thermal cabin ceilings?

The simple answer is “as low as possible.” Ceilings should be no more than 30 cm above the head of an average height bather sitting on the highest level of benches. If a sauna or steam room bench is at 90 cm and the top of an average height person’s head is 90 cm above the bench, then the ideal cabin height is 210 cm (or 84 inches). Current trends lead architects and designers to want to create spaces with very high ceilings, but these trends are detrimental to the bathing experience of the guest.

The higher the room, the less efficient it is not only in warming the guest but also to operate as it will require far more energy to heat a large volume of unused space. It is true that traditional saunas were much higher structures, but in such structures the seats were frequently also at a high level, leading them to be described as “loft” or “gallery saunas,” where the

seats are close to the eaves of a pitched roof cabin on a gallery that is built around the heater on a lower level.

The exception to this ceiling height rule is a traditional hamam. Turkish hamams, in particular, have very large domed roofs pierced by ‘elephant eye’ glazed openings through which natural light streams. Hamams were traditionally heated by a hypocaust or underfloor heating system, so the warmth from the floors and horizontal seating surfaces radiated heat upwards. Early architecture didn’t consider the energy efficiency of the buildings. Today, this design style can be replicated but will also incorporate heat recovery technology to ‘recycle’ the heat from these voluminous domes while exhausting stale air.

Steam room ceilings often gather condensation: how can this be minimized?

The secret of this is to create a warm roof, so when hot steam comes into contact with the surface of the cabin roof or ceiling, it is not instantly cooled by a cold, smooth surface. So there are two critical factors here: the level of insulation on the ceiling is vital and the choice of material used to decorate or finish the ceiling is also important.

Guidelines for Ceiling Construction

Finish and Insulation	Ceiling Pitch/Style	Performance
Ceiling Type: Insulated building board at least 8 cm thick		
Heavy textured render or sprayed on popcorn type texturing with waterproof paint finish	Flat	Well insulated; texturing prevents condensation adhering to the surface
Smooth render and waterproof paint	Pitched or curved as in a barrel vault, to avoid dripping, allowing droplets to run to the sides	Well insulated, but smooth surface will produce drips unless it is sloped or curved
Tiled with mosaics	Will drip regardless of the style/angle as the joints in the mosaics will form droplets that cannot run away, even on a sloped surface	Poor, not recommended
Tiled with large format tiles or stone	Less likely to drip than mosaics, but joints in the material mean drips will form, even on a pitched or barrel vault roof	Can work with good design and craftsmanship
Ceiling Type: Stud framework and various types of board cladding		
Difficult to reach levels of insulation necessary to construct a 'warm' roof. Typical U value for a thermal cabin ceiling is 0.39 which has an equivalent R value of 14.6	Must be sloped or barrel vault roof	Poor, not recommended. The materials typically used to clad 'drywall' type structures are rarely moisture resistant and not capable of forming a completely waterproof membrane between the board and the structure; runs the risk of mold formation, unpleasant odors, structural deterioration and possible collapse
Ceiling Type: Fiberglass (also known as GRP (glass reinforced plastic/polymer); FRP (fiber reinforced plastic/polymer) or FCP (fiberglass composite plastic/polymer))		
Normally smooth, with a pigmented gel coat or possibly even a fine acrylic membrane bonded to the surface to give decorative finish to resemble stone or granite. Must be insulated, with spray insulating foam of only 2.5 cm	Requires a pitch because the typically low levels of insulation cause high levels of condensation	Useful if specific themed effects are required, but the need to make moulds to form the roof panels can be costly if customized; more common on 'standard' sized and symmetrically shaped rooms. U (or R value) is low, so can lack necessary warmth

Lighting and Audio/Visual

Integrating lighting into thermal cabin ceilings can be done with a great many designs and materials, but the presence of high levels of heat and moisture creates certain limitations, so it is vital that any proposed 'standard' fittings being considered are tested for such applications. The advancement of fibre optics and submersible LED lighting has opened up a great many more creative opportunities for these cabins. The main points to consider are the future accessibility of light sources for maintenance and replacement, it should be remembered that LEDs don't last forever, so continuous LED strip lights will eventually have to be replaced. With the design community favouring indirect and concealed lighting, any recesses, particularly in 'wet' rooms, must be designed in such a way that condensing steam and humidity cannot build up in these recesses as such an event would cause electrical safety and health and hygiene issues.

Lighting and audio/visual add significantly to the ambience of hydrothermal cabins. Lighting for aesthetic purposes can be quite sophisticated and multi-dimensional, including changing colors and specialist effects. It's important to remember to provide lighting for cleaning and maintenance.

Similarly, music and sound effects are used to create the required ambience. This means the provision of a programmable MP3 player/controller is required, together with waterproof speakers, resistant against both humidity and corrosion.

Newer developments in audio/visual include TV installations with specialist waterproof monitors and other broadcasting components.

Lighting plays an important role in the spa—the environment can be changed completely simply by changing the colors the lights are emitting.



Spa Management System Functionality

- Acoustic sound off/on (music and alarm)
- Acoustic volume control (music and alarm)
- Activation signal (e.g., panic button)
- Maintenance issue alerts (e.g., light outages; water leakage; low levels in dosing system; etc.)
- Equipment off/on
- Fan speeds/air extraction rates
- Fault signal/message
- Lighting-level adjustment
- Set/monitor timers
- Room-temperature monitoring and adjusting
- Water/steam-temperature monitoring and adjusting
- Service reminders
- Password protection and restricted access
- Remote control access via Internet connection

Building Management Systems

Building Management Systems (BMS) allow control and monitoring of all the building services—including HVAC automation, energy control/consumption, access control, video surveillance, ventilation, security and fire protection—from a single point. In addition, they enable easier operation and maintenance of all functions of a building. In the case of hotel installations, a BMS may already be in place and it's often possible to adapt the BMS to the spa environment.

However, the best practice is to install a separate spa technology management system as a standalone system that works independently of a BMS and allows users to control and monitor temperature, lighting, music, etc., from a central screen at the reception desk; control panels should be in place throughout the spa to manage and maintain various equipment and functions. These control panels gather relevant signals and alerts, routing them back to the central unit. Warnings/alerts can be issued when a light bulb has gone out, temperatures are above or below normal,



Today's technology means all aspects of a hydrothermal spa—including individual cabins—can be controlled and monitored remotely.

Smartphone apps puts the control of hydrothermal areas into the palm of your hand.



a therapist or guest has pushed a panic button, water ingress/leakage is occurring, etc.

It's important to note that there is a downside to remotely controlling thermal rooms and pool installations. If you take the need for physical checks out of these areas, there's a risk that problems in the system will go unrecognized/unseen. For example, there could be water leakage or even risk of fire that go unnoticed because no physical checks are being made.

There are standard rules and regulations (in fact, laws in many countries) that insist thermal cabins and pools be checked physically every six hours—in this case, the cabins are set to switch off every eight hours of operation, so that a physical check is guaranteed to be conducted and the experience turned back on. However, a BMS system can be programmed to override the physical check by simply turning the experience on remotely. To avoid this happening, a key switch or touch panel with a pin code should be positioned at the thermal room or pool itself, and it must be programmed not to re-start until a staff member has physically checked it.

Connected Wellness

Another opportunity in today's spa builds, is putting technology in the palm of everyone's hand and allowing for "connected wellness." Wet treatment zones can be made more efficient while providing a better, more customize, level of experience for the user and increased safety and support in running a spa.

Both commercial and residential spas benefit from "connected wellness" in their wet treatment and showering areas—giving guests the ability to manage lighting, sounds and scents at the touch of a finger. For this to be effective, all product solutions must have a standardized interface (e.g. KNX, IP, DALI, etc.) to enable communicating with each other and, in the case of a commercial build, will require a server to run them.

With "connected wellness," rooms can be prepped and customized with the touch of a finger, welcoming guests with their favorite scents, light atmosphere and relaxing sounds and a warmed up shower.

Connected solutions can be controlled remotely and

send status information to a main desk, so that spa staff is instantly informed when certain treatments/experiences are in use and can alert staff to any issues.

The “Smart” Spa

Today, there is a plethora of smart devices and apps available for controlling every aspect of a residential or commercial spa—including temperature, lighting, aromatherapy, audio options and more. In order to explain the various systems, we’ve separated out residential and commercial options but smaller hotels, spas, health clubs and wellness centers will also want to consider exploring systems designed primarily for use in the home.

Connected Wellness at Home

Just as more and more people are adopting smart devices in their homes to control appliances, lighting, temperature, music, security cameras and the like, it’s become more common to use a smartphone and an app to control home wellness equipment.

Given how far this technology has come, there is almost nothing that can’t be remotely controlled by the homeowner—so as long as the home is equipped with a robust networking systems, either Wifi or hardwired, the sky’s the limit. However, it’s important to be aware of the potential safety and even ecological concerns that come into play when remotely controlling temperatures and operating times in these specialist rooms.

For example, a home sauna with a smart controller should also be fitted with a door contact switch so that the app can verify that the door is closed before activating the heater. The app will enable the homeowner to pre-select an operating temperature and to turn the sauna on at a given time and for a fixed duration. If the sauna has multiple functions, such as a SANARIUM® or Bio Sauna, then these can also be selected from the app.

Lights and music selections can also be controlled if the operating system has been fitted with this function and some of the today’s equipment supports voice commands via Alexa or other similar technology.

Commercial Connected Wellness

While it’s certainly possible to also employ a wireless system in a commercial spa, the preference is to incorporate hardwired networking into a public spa area. The reasons are two-fold: first, there are well-documented concerns that long-term exposure to wifi signals and the associated electromagnetic frequencies from the devices they support—routers, phones and other smart device—could be harmful to our health (something that might also prompt homeowners to opt for hardwire solutions). Health questions alone are likely a big enough deterrent to placing wifi equipment in a building designed for improving wellbeing, but, practically speaking, hardwiring makes much more sense in a space where there are a multitude of small rooms and corridors that are not conducive to good WiFi communication.

When choosing a spa technology management system that works independently of a traditional BMS, operators will gain increased functionality and flexibility because standard BMS systems don’t often support the wide range of spa equipment and interfaces currently available.

Of course, the network cabling that runs each piece of equipment will need to be taken into account in the planning stages of the spa. After installation, the spa management system will allow different user levels to be set, so, for example, a screen at the reception desk could keep staff informed of all operating temperatures, start/stop times, dosing system levels and guest alarm activation, but access to the equipment control, set up and diagnostics could be reserved for higher-level users.

Plant/Mechanical Rooms

One of the most common mistakes made in hydrothermal spa designs is the omission or poor planning of the size and location of the plant/mechanical room. And, of course, without the mechanics/equipment that runs the thermal and pool areas, they simply won't operate. This means much consideration should be given to the location and size of the plant rooms during the building design stage.

Expert input is necessary to understand plant/mechanical requirements of the various hydrothermal areas. In simple terms, a heated swimming pool will have a larger plant room than a salt cave, while a sauna or steam room's mechanics can either be located on the outside of the cabin, or in a plant room located a short distance from the cabin. All should be discreetly accessible by qualified personnel at all times.

Plant rooms have two important functions:

1. They house the major water, electrical and HVAC systems that support the thermal room or pool.
2. They offer access to equipment, e.g., dosing systems that require replenishment and maintenance, along with the major water, electrical, HVAC installations that support the entire installation.

Example of a small plant room for maintaining a hot tub or spa pool.





Health, Safety and Hygiene

.....

Consideration for the health and wellbeing of users begins when a spa is in its earliest design stages. Whether building a residential or commercial spa facility, it's important to take into account the factors that affect the wellbeing, either directly or indirectly, of the people using the thermal cabins and pools.

.....

The “health” of any building—regardless of usage—is something designers/architects have been becoming more and more aware of in recent years. In the case of hydrothermal builds, the most important health and safety factors are governed by the successful implementation of these core elements: heating, ventilation, air conditioning, building materials and cleaning agents.

By their very nature, hydrothermal areas, with their extensive use of heat and moisture, are ideal environments for the growth of fungus and mold—something that can be controlled during the design and building process and maintained through proper maintenance and cleaning. In addition, the high levels of moisture make the surfaces (floors and benches) incredibly conducive to slipping—another factor that is easily mitigated by using the correct materials.

The high, ambient temperatures used throughout the building to keep wet and minimally clothed bathers comfortable means that waterborne fungus and mold

High, ambient temperatures combined with large amounts of water means it's important to keep hydrothermal areas well cleaned and maintained.



When designing all aspects of the spa, consider minimal joints and grouting. This not only makes cleaning and disinfecting easier, but are also longer lasting.

isn't only an issue in the thermal cabins and pool areas—they can also surface in other communal and relaxation spaces.

In Design

Increasingly, more and more spa designers, owners and operators are actively engaged in the promotion and development of healthy buildings. They understand that it's important to be able to deliver the benefits of health and wellness treatments/experiences in a building that is specifically designed to be “healthy and well.”

In the broadest sense, a “healthy building” is designed with the goal of reducing any negative impact it might have on occupants and the environment. That means using building materials and best practices that minimize risk to a person's health—whether that be through illness or accident.

During the design phase, it's imperative to consider and analyze the materials that will be used and to understand how they will withstand the effects of steam, sweat, oils and cleaning water/agents.

In thermal rooms and communal spaces, it's important to choose surfaces (benches, floors, walls) with minimal

joints, thus avoiding the need for excess grouting. This makes cleaning and disinfecting easier, and, ultimately, longer lasting and requiring less maintenance. Additionally, specialist building materials, such as mortar-coated, expanded, polystyrene hard foam, make it possible to clad walls, floors, steps, benches and shelves in ways that are completely waterproof and mold-resistant. For example, in contrast to plasterboard, hard-foam polystyrene has been proven to prevent the formation of mold due to its alkaline properties. So usage of this humidity-resistant building board will minimize the risk of infection or allergies because it doesn't provide a suitable breeding ground for microscopic organisms or germs.

Proper drainage planning is also imperative, as it plays a major role in the health of a hydrothermal building. All excess water used during treatments and in cabins and pools must have somewhere to go. Correct drainage keeps bacteria from breeding and also minimizes the slip risks caused by wet and dirty floors. (Not surprisingly, slipping and falling is the most common accident that can occur in a spa area).

Ventilation also plays a key factor in the health of the building and the health of those in it. In addition to

Loungers finished with large-area heat storage ceramics are easy for cleaning and maintenance.



Courtesy: Sommerhuber

the ventilation requirements outlined in Chapter 8, it is essential to ensure smooth, not flexible, exhaust ducts are installed and that they fall in the direction of a drain point(s). This is imperative to avoid any pooling or lying of water in the ducting, preventing the incubation of legionella bacteria, the exposure to which can cause potentially fatal pneumonia. In cabins that are highly affected by heat, water and humidity, there should be a ventilated cavity between the room walls (or cladding) and the building walls.

Of course, cleaning and maintenance play a key role in minimizing health risks in any building. Wet and humid areas are difficult to clean and maintain at the best of times—in any building, the bathroom is the most susceptible to fungus and mold. This makes it vitally important to design the building/space while having the perspective of the person(s) who will clean it in mind. For example, consider creating rounded versus square corners for easier cleaning and always use sloped surfaces to avoid unhygienic pools of water on seats and other flat surfaces. Make sure there is an easy path for water and cleaning solutions to reach the drainage in the floor.

Emergency call systems, like those found in the healthcare industry, should be included in the design phase. These systems will alert staff to incidents or accidents, and, because all areas of a hydrothermal spa have associated risks, these systems should not only be adopted in the most “at risk” spaces (such as the thermal cabins and pool areas) but throughout the facility.

Key Design Considerations for Health/Safety/Hygiene:

- Proper drainage to avoid excess water that can cause slips and/or breed bacteria
- Ventilation that enables the proper flow of oxygen and condensation
- Emergency call systems
- Measures for easy cleaning and disinfecting of all areas
- Building materials that minimize the growth of mold and bacteria

Disabled Access in Hydrothermal Cabins

In addition to being aware of a hydrothermal area's potential health and safety risks to all visitors, it's also important to consider specific access issues for disabled individuals. In many countries, planning access for the physically disabled is the law, however, regardless of legalities, it's also a positive sign of inclusiveness and enables a facility to serve a broader number of people. And, of course, individuals with motor or physical disabilities will greatly benefit from hydrothermal treatments.

Though each country will have its own specific codes and rules prohibiting discrimination against people with disabilities, it's the Americans with Disabilities Act (ADA) that has made the greatest impact on hydrothermal builds. In particular, the state of Florida published its own interpretation of the ADA in 2012 that has a direct impact on the construction of thermal cabin builds and, it's worth noting that the addendum to the ADA is gaining widespread adoption not only in the US, but wherever US operators build in the world. The code specifically covers wheelchair access to saunas and steam rooms and all derivatives of these cabins (including hamams, tepidariums, etc.).

Key Aspects of the Code

- Each cabin requires a dedicated wheelchair parking space that measures at least 760mm wide x 1220mm deep (or 30 inches x 48 inches)
- Wheelchair parking must be located at the end of a bench and parallel to the short axis
- A bench of at least 1065mm (42 inches) wide and between 510mm to 610mm deep must be kept clear immediately adjacent to the wheelchair parking space
- The bench needs to be between 430mm to 455mm (17 to 19 inches) above the floor
- If the bench is not against a wall, it must have a backrest at least 455mm (18 inches) high
- Benches must have slip resistant finishes

Note: Non-permanent furniture elements can be located in the wheelchair parking spaces, so, for example, a sauna can be designed with a removable or retractable bench section that will provide the correct size parking space when removed/retracted.

Other general disabled access features to keep in mind when building a hydrothermal area:

- Entry ramps
- Correct door widths
- Correct clearances on the pull and push side of doors
- Low-level emergency button inside the room for assisted exit
- Low-level bell at entrance to request assisted entry
- Disabled bathroom
- Accessible changing and locker rooms, shower area
- Treatment rooms on the ground floor and/or lifts to upper floors
- Wheelchair access to treatment rooms (corridors, doors, and turning radius)
- Hydraulic treatment tables for easy access

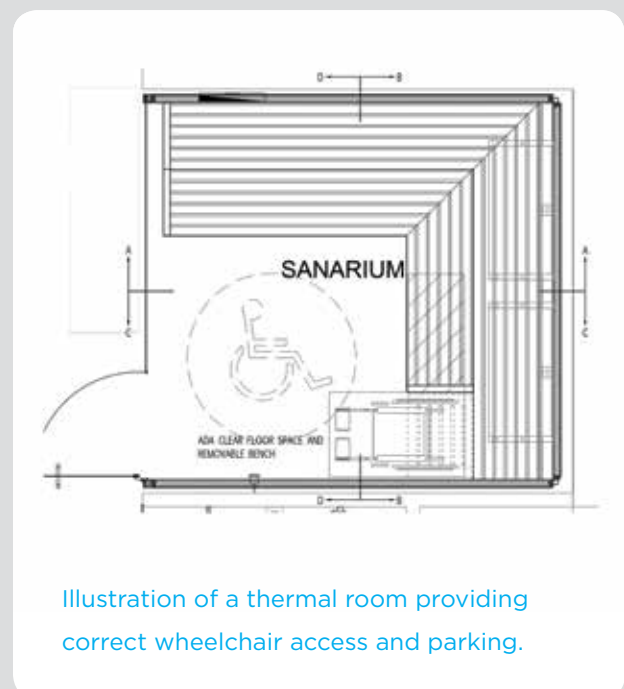

Illustration of a thermal room providing correct wheelchair access and parking.



Common Mistakes

In Construction

Of course, the goal is that most risks are eliminated during the design stage. However, no matter how focused designers and architects are on these points, the construction phase is often where even the most conscientious professionals can see radical changes to their original specification. This is the phase when most changes are implemented, in particular, “value engineering”—where specified materials, equipment and services are modified or omitted in order to save money.

Often, during the design phase, clients are unwilling to agree to specified, branded products in tender documents and/or drawings. This means design intent can give way to financial pressure during the actual build. Product substitution is a frequent practice in the construction industry, and, though designers will reference a particular product or manufacturer, contracts will often carry the clause to allow for “or equal and approved” products. This invites contractors to offer financial incentives by providing products they feel are more competitively priced but often don’t offer the same quality. And, of course, budget constraints means these “alternative” products are frequently accepted because they provide significant short-term cost reductions.

Of course, this short-term financial gain can lead to the construction of substandard hydrothermal areas that quickly fall foul of health, safety and hygiene standards after construction.

In Operation

“Don’t expect what you don’t inspect!” is the best advice for spa operators. A clean and healthy environment in which guests can enjoy the facilities is the responsibility of the spa manager—whose job is to supervise the staff and ensure vital duties are performed at all levels.

- Emergency call buttons in wet areas are designed to withstand heat and water. A wet area specialist will install them in thermal cabins and pool areas but they are not responsible for the entire call system which must be integrated by an M & E consultant.
- Leading with design and not considering safety/health
- Not allowing for disabled access and installing as an afterthought
- Forgetting slip-resistant flooring for wet area floors and multi-tier seating
- Cleaning tiled areas with pressure washers that end up blowing grout from the joints, creating bacteria and mold traps
- Not using heat resistant materials for handles in saunas
- Not ensuring that all doors to thermal cabins open out and have non-mechanical latching systems or heavy self-closing devices
- Incorrect ventilation causing poor air quality and/or condensation in ducting
- Failure to consider installing automatic water sanitizing and automatic disinfection of popular wellness experiences, like foot spas and Kneipp walks, after used by a guest
- Failing to use sterile salt/brine solution in nebulising inhalation systems
- Use of low quality aroma products in emulsion carriers instead of essential oils (chemical based aromas are often sold without Material Safety Data Sheets (MSDS) and could expose an operator to potential claims
- Not installing backflow prevention valves in experience showers and other features in which aromas are injected to water flowing from the main circulation system will risk polluting the whole water supply serving the property

Pool Water Safety

Pool staff should be trained to conduct regular testing of the pool water. Below are testing guidelines:

Daily Tests (Every 2-3 Hours)	Water Quality Values
Free Chlorine	Range 0.5 to 3.0 mg/l (Aim for 1.0 to 2.0 mg/l)
Combined Chlorine	Not more than one third of total chlorine
pH	Range 7.2 to max. 7.6 (Aim for 7.2 to 7.4)
Weekly Tests	Water Quality Values
Alkalinity	100 ppm to 180 ppm Sodium Hypochlorite 100 ppm to 120 ppm Calcium Hypochlorite
Calcium Hardness	200 ppm to 1000 ppm (not less than 200 ppm)
TDS	Total Dissolved Solids Max. 1000 ppm above source water
Pool Balance	Refer to Langelier Saturation Index

Pool Chemical Room Safety

Careful consideration has to be given for safe delivery of chemicals, including offloading and transfer within the building, avoiding stairs where possible.

Storage: Adequate, separate storage and containment space must be provided for the chemical containers and bags required for the normal daily and weekly refilling of the operational chemical day tanks.

Containment Bunds: A chemical bund area should be constructed in concrete with a cement render internally and finished with a chemical-resistant (or fiberglass-lined) material, providing a fully contained bund capable of holding 110% of the maximum chemical volume.

Segregation: Separate enclosures should be maintained for all potentially hazardous chemicals (acids and alkalis) in separately ventilated rooms, with a minimum of four air changes per hour.

Drench Showers/Eyewashes: Emergency drench showers/eyewashes are recommended in commercial chemical rooms.

Eyewash: A sealed sterile type of eyewash bottle should be located near the intake point and in the chemical stores

Sink: A large sink with hot and cold running water is required for cleaning the chemical injectors.

Risk Assessment

In any business, there is the potential that a staff member or client can be injured or become ill as a result of an incident occurring in the workplace. This is why, whether it's a legal requirement or not, operators should carry out risk assessments on all aspects of their spas. Everything considered a potential risk should be fully documented. Further safeguards to assist operators in refuting or diminishing any claims that may occur: keeping thorough cleaning and maintenance records, as well as customer-usage numbers and chemical applications.

A risk assessment looks at the steps to be taken to eliminate and control risk and examines every possible “what if” scenario.

Risk Assessment Should Include the Following

- Identification of all hazards (such as slippage, waterborne illnesses, chemical imbalances, etc.)
- Evaluation of the associated risks
- Consideration of the severity of the consequences and chances of it occurring
- Identification of all persons (including staff, contractors, guests) at risk
- Establish control measures to prevent risks
- Ensure staff and guests are aware of any potential risks and symptoms
- Identify specific legal duty or requirement relating to the risk

Control Measures to Consider

Thermal Areas

- Display clear instructions in prominent positions explaining how equipment should be used
- Minimize/eliminate potential for scalding or burning
- Ensure proper ventilation and drainage
- Conduct and document regular cleanings and checks—hourly, daily, weekly, monthly, yearly
- Test alarm systems regularly
- Always provide a supply of drinking water for guests and staff

Pool Areas

- Display clear instructions about safe usage
- Follow a daily, weekly, monthly and yearly cleaning and maintenance routine
- Regularly test waters for disinfectant, pH levels and clarity
- Check filters and backwash as advised
- Drain and clean system as advised
- Ensure plant room and chemical storage area is well-ventilated
- Clearly label and store chemicals away from each other
- Follow applicable legal legislation for handling of chemicals

Wet Area Hygiene

Hygiene is important at every level of a spa—from pool water treatment and the correct design of ventilation ducts to the effective daily cleaning of floors and the deep cleaning of body fat residues from steam baths. This has a direct impact on the health and safety of the spa.

Major Health, Safety and Hygiene Risks

- Accidental slipping due to poorly specified, cleaned or badly drained surfaces
- Bacterial cross-contamination from user to user
- Fatal waterborne illnesses, such as legionella
- Numerous illnesses, such as ear infections and viral conditions, transferred via poor pool water treatment and sanitizing

There are specially designed acidic cleaning solutions for tiles, fittings and accessories that will dissolve lime deposits and grease scum gently, while specialized pipeline disinfectants attack waterborne germs and fungus their its source.



Sustainability and Regenerative Design

Where “green design” and sustainability have dominated the last two decades of the building industry, today’s experts are adopting concepts of regenerative design and wellness architecture—practices that move away from doing “less harm” and focus on symbiotic relationships to the local ecology while enhancing all dimensions of wellness in order that both humans and the planet thrive.

This chapter was written in collaboration with Veronica Schreiber Smith, Chair of the Global Wellness Institute’s Wellness Architecture Initiative.

Spas by their very nature are inherently focused on not just sustaining guests’ health and wellbeing, but enhancing their overall wellness in order to help people live longer, more vibrant and more fulfilling lives. The architecture that houses spas should do the same by not just delivering sustainable, but regenerative environmental solutions, and integrating wellness strategies that deliver experiences with meaningful impact.

Many spas embrace environmentally friendly design by closely scrutinizing the products they offer; reducing single-use supplies with durable beverage cups, cloth hand towels or microfiber body wraps; and simply asking clients to reduce the time spent in showers and to reduce the number of towels they use.

Sustainability means thinking about alternative sources of power, such as solar and wind power.

Of course, there's much more spas can do to positively affect the world in which we live. Sustainability is a beneficial subset of regenerative design and wellness architecture, which is best considered early in the planning and building stages of a hydrothermal spa area. These practices are not only good for the environment, they enhances the outcome of offerings, are good for the reputation of the industry, and, last but not least, will have a positive impact on the profitability of your spa.

What was once thought of as “going green” has evolved from a passing trend into a long-term commitment to regenerative design and wellness architecture—the practices of making choices that have a positive impact on both people and the planet.

Sustainable & Healthy Material Selection

Designing a wet area from the ground up provides the opportunity to think about integrating sustainable and regenerative strategies into every aspect of a hydrothermal spa. There are numerous ways to

bring wellness into the build—including conscious consideration of the building materials and products being used to construct the cabins and pools.

To minimize the impact on the environment, many providers and manufacturers to the hydrothermal industry have adopted “green” practices, including reducing the amount of emissions that are released into the atmosphere, using less raw materials, recycling waste material and extending the durability of their products. This last point is important, because, although the expense of sustainable and eco-friendly solutions is often greater at the offset, costs in the long run are typically much less.

But environmental considerations are only half of the selection process. How a material or product impacts human and planetary health over the course of its existence is the other half. Wellness strategies, for example, consider the elimination of toxins and pollutants, favor natural materials over synthetic ones, utilize nudge psychology to influence guest behavior, and intentionally enhance the local ecology, economy, and culture.

Comparing Insulation Value of Common Building Materials

The lower the U-Value, the more optimal the insulation properties of the material; conversely, the higher the R-Value, the more optimal the Insulation properties.

Wall Material	Thickness (MM)	U-Value (Low Value=Good)	R-Value* (High Value=Good)
Insulated Dry Wall	150	0.35	16.23
Concrete Blocks	200	0.39	14.6
Brick Wall	200	0.41	13.9
Poured Concrete	250	0.55	10.33
Hard Foam Building Board	50	0.59	9.6
Natural Wood/Rock/Sheep/Mineral Wool	50	0.59	9.6

**R-Value is measurement used in USA*



Common Mistakes

The first step is to research the provenance of the materials and products that are being used to see if they follow the environmental and wellness ethos of your hydrothermal spa. For example, look at the woods chosen to build the sauna and/or banya—are they being sourced sustainably from managed forests? Are the tiles made of sustainable materials, and/or do the tile suppliers adopt eco-friendly practices throughout the manufacturing process? If you are sourcing an entire cabin, has it been designed and manufactured with wellness at its core?

Effective Insulation

Since heat is such a huge part of a hydrothermal spa—and with heat comes the attendant drain on electrical and/or gas resources—it's imperative to pay close attention to insulation. Thermal insulation saves costs and energy by reducing the working hours of steam generators and heating; it also reduces the maintenance costs of this equipment. One of the most common (and, ultimately, most costly) mistakes a builder makes when constructing a thermal cabin is the use of materials that do not effectively hold heat or withstand moisture. Building a sauna or a steam room with materials that are used throughout the rest of a building will likely result in rooms that are very costly to heat up—both in terms of cost to the environment and actual monetary expense to the operator. The insulation value—called “R-value” or “U-value,” depending on the country of origin—of the materials being used is incredibly relevant. For example, common building materials, such as concrete blocks and plaster, have poor R-values and will suck up the heat before the cabin itself will heat up. A sauna using concrete blocks might take two hours to get to the correct temperature, while a sauna of the same size constructed using specialized insulation techniques and hard foam boards, or even a natural fiber insulation board, will take just 20 minutes to get to temperature.

In a steam room, insulation is also important in water conservation—a properly insulated room will require less steam to be delivered to create the correct humidity levels.

- Not willing to commit to a bigger initial investment for the savings to payoff in the long-term.
- Uncontrolled usage/consumption of water.
- Concrete is only a green material in its raw, base-component format, as all constituent parts are from the earth, but it is the production and transportation of concrete that causes all its green credentials to fall away.
- Building everything from scratch on site is not as green as the use of prefabricated structures, built in a factory with all waste materials harvested and disposed of ethically or recycled professionally. E.g., wood sawdust can be reused, wood offcuts can heat a sauna factory throughout the winter, expanded polystyrene offcuts are harvested in the factory and recycled into yogurt pots, etc.
- Just having “green” products is not enough for sustainability; owners and developers need to look at every element of spas from the ground up for human and planetary wellness.
- Water recycling is not just the job of infrastructure and utility providers—spas can do it to.
- Not harnessing air and heat energy used in the spa somewhere else—e.g., producing snow and ice creates a lot of heat; employ a heat exchanger to use that heat to add a few “free” degrees to the water being used for the vitality pool.
- When selecting materials, a sole focus on performance criteria without consideration for health concerns often leads to specifying toxic materials that off-gas and harm the environment.

Saving Energy

Energy consumption in thermal rooms varies greatly according to the method of construction and the selected finishes. The denser the material, the more energy it will take to heat the structure, rather than the bathing atmosphere.

For example, a concrete room with 20 mm-thick granite finishes will take an enormous amount of thermal energy to heat the structure before the room can be at bathing temperature; in colder climates this can take hours and cost a great deal of money to operate. Therefore, considering the thermal effectiveness of the building materials used is imperative.

The same consideration should be made for swimming pools, especially in colder climates where concrete shells can absorb enormous amounts of energy, while pools made from far thinner materials such as fiberglass or stainless steel can be insulated.

Some examples from a simple steam room (steam output is measured in kilograms per hour (kg/hr) or pounds per hour (lbs/hr) are shown below:

- Concrete with granite finish requires 1.2 kg/hr of steam, equal to 0.9 kW in electrical load
- Insulated, coated foam boards (or natural insulation when possible) with the same finish require 1.0 kg/hr of steam, equal to 0.75 kW in electrical load
- In simple terms, the energy used by a concrete/granite room will be 20% greater and, therefore, cost 20% more to run.
- Given that the average life of a steam room is at least 10 years and often a lot more, the low cost of “traditional” building materials at the outset may reduce the capital costs of the project, but the ongoing higher revenue costs of inefficient construction will last the life of the steam room and far outweigh the initial saving.

Water Conservation and Recycling

As water is such a huge part of wet area spa builds, a particular focus must be put on all areas being waterproof and watertight. One simple way to manage water waste is by installing sensors on faucets and showers so that water is never left running by guests or staff. Showers can also be programmed to shut off after a certain amount of time to minimize waste, and, of course, low-flow toilets should always be used.

When installing an experience shower in a spa where water conservation is top of mind, consider these options:

- Set program times so that the spa operator controls length and the guest can't forget to shut the water off.
- Mist nozzles are an alternative cooling source to the water-consuming waterfalls, bucket showers or deluge jets. The gentle “misting” cooling effect is a very pleasant and water consumption is only 6 liters per minute while deluge showers frequently use 20 liters per minute.
- Recycling cooling shower water is most definitely the way forward and this technology is being developed.

If pools are included in a spa build, be sure to use materials that are proven to be the most effective at retaining water—such as stainless steel or composite GRP (fiberglass) versus cement. Water leakage is the biggest problem in pool builds but can be easily avoided by using the correct materials. In addition, minimizing water waste while the pool is in operation is important. A centrifugal pre-filter is a low cost piece of equipment that can be added to almost any pool system. The centrifugal pre-filter removes solids from the water by spinning it before sending it to a traditional sand filter, removing solids before they get trapped in the filter media. This can significantly reduce the backwash frequency of the pool system, thus saving water and minimizing the discharge of chemicalized water into the drain system.

The Omega Center for Sustainable Living is a great example of a property focused on sustainability and regeneration and it was the first building in the United States to achieve both LEED® Platinum and Living Building Challenge™ certification.



Ecological Solutions

In combination with a central control system for the wellness area, the rooms that consume the most energy (sauna and steam rooms) can be controlled according to frequency of use. With the help of door switches, the performance/power consumption of sauna heaters and steam generators will be reduced when the door has not been opened for a certain period of time, something that can be customized to an individual operator's needs.

Alternatively, heaters and generators can be switched-off or reduced in power consumption when a door is left open, so they stay warm, but not hot, returning to bathing temperature quickly when the door is opened.

When designing mechanical and electrical systems, first consider reducing loads, second integrate climate appropriate passive strategies, and then turn to renewable energy sources—such as solar or wind power—for generating electricity to run a hydrothermal spa where possible. There are many affordable ways to utilize alternative energy sources, such as solar power, by integrating solar-roof panels to heat water for the pools and showers. Ground source heat pumps, which harness natural ground heat by pumping water through underground pipes, require

less electrical energy and are an extremely sustainable and effective method for heating and cooling water. Tankless or on-demand water heaters, which heat water as needed versus a water heater that features a continuous heating source, are another option, but, because the water flow rate is not likely to meet the needs of guests in a large spa, these might be better to supplement other heating solutions. Remember, short pipe runs, where possible, and proper insulation will go a long way in reducing heat loads and energy. And, if there's an option to use an electricity or gas supplier that provides green-sourced energy, you can be “green” with minimal effort and outlay of cash.

Of course, making and supplying your own energy is, more often than not, cost-prohibitive. In this case, it's important to focus on other ways to save on energy waste by using appliances that are rated energy efficient (e.g., the Energy Star rating). And, although people are becoming more conscious of energy conservation, relying on staff and guests to shut off lights when not in use is not enough; instead, consider installing sensors that will dim or shut lights off completely in unused areas of the spa.

A simple way to manage water waste is by installing



Vertical forests and living walls are part of the biophilic design trend which seeks to incorporate nature into design—a practice that not only minimize the stress of inhabitants, but also improves the air they breathe.

similar sensors on faucets and showers so that water is never left running. Showers can also be programmed to shut off after a certain amount of time to minimize waste. Low-flow toilets should always be used; additionally, look to recover water wherever possible for reuse. For example, use all-natural, biodegradable soaps in the shower areas so the water is re-treatable and re-useable.

If the hydrothermal spa is in an area that benefits from large amounts of rainwater, explore a rainwater-harvesting system that will collect and filter rainwater for use around the spa.

Getting the ventilation and climate control correct in the pool area will pay off in the long run by combating evaporation—another huge water waster.

Sourcing products for the hydrothermal area that are eco-friendly throughout their lifecycle minimizes waste in the long run. A good example of this can be found in today's choice of steam generators. Steam generators that are designed with eco-principles tend to cost more initially but can last up to 20 years versus a more affordable model that may last only three years. The implications on the environment are numerous. The cheaper unit will be sealed so repairs are impossible—which means it ultimately ends up in the landfill and a new unit must be purchased, while the more expensive steam generator allows for both repair and recycling.

Economic Advantages

The economic advantages to building a sustainable and eco-friendly hydrothermal spa are numerous. Up-front investments in sustainable designs and technology promise to deliver financial paybacks over the life of the building in the form of lower utility bills and reduced operating and maintenance costs. Regenerative design further increases these paybacks.

Additionally, wellness strategies don't just stop at the health impact for the guests, they take into account all aspects of a project's potential capital—financial and physical capital being the most commonly considered, while natural, social, and human capital are often forgotten. Evaluating how your project can maximize all five of these key areas will ensure long-term economic success.

Another less obvious, but equally important benefit is the goodwill created by these initiatives with both the local community and guests. Everyone wants to be part of an ethos that enhances both the health of the planet and human wellbeing. In short, integrating sustainable and regenerative environmental solutions with wellness strategies will create unique marketing opportunities for a hydrothermal spa.

Explore sustainable, regenerative, and wellness strategies with your team to save money in the long run!

Additional Resources for Sustainable and Regenerative Design

BREEAM

www.breeam.com

The world's leading sustainability assessment method for master-planning projects, infrastructure and buildings.

Building Biology & Ecology

www.hbelc.org

International organization providing principles and education focused on optimizing the built environment for human health.

Green Globe 21

www.greenglobe.com

Certification for the sustainable operations and management of travel and tourism companies and their related supplier businesses.

Green Spa Network

www.greenspanetwork.org

Sustainability assessments and easily adoptable practices for spas.

International Living Future Institute

www.living-future.org

ILFI partners with local communities to create grounded and relevant solutions, including green building and infrastructure solutions on scales ranging from single room renovations to neighborhoods or whole cities.

LEED (Leadership in Energy & Environmental Design)

www.usgbc.org/leed

LEED certification is recognized across the globe as the premier mark of achievement in green building.

WELL Building Standards®

www.wellcertified.com

The WELL Building Standard® is an evidence-based system for measuring, certifying and monitoring the performance of building features that impact health and well-being.

Whole Building Design Guide (WBDG)

www.wbdg.org

Provides government and industry practitioners with one-stop access to up-to-date information on a wide range of building-related guidance, criteria and technology from a 'whole buildings' perspective.

Glossary

Aromatherapy

The use of aromatic plant extracts and essential oils in massage, baths, showers and thermal cabins

Aquapressure

Targeted water massage. Similar to acupressure.

Aquathermal bathing (synonym “hydrothermal bathing”)

Pertaining to the temperature effects of water used in thermal cabins and pools (Origin Greek)

Arctic ice Room

Operating at 1° C to 4° C,, these rooms provide contrast therapy to the hot rooms in a spa and mimic the traditional experience of a “roll in the snow”

Balnea/Balneum

Smaller version of a Roman thermae (bathhouse) found in ancient Rome (Origin Latin)

Balneotherapy

General term for water-based treatments using natural thermal, spring, mineral or seawater to induce relaxation, improve the circulation, stimulate the immune system and bring about detoxification (Origin Latin)

Banya/Banja

Term originally meant “bathhouse” in Russia but has been adopted to refer to the specific sauna-like room in a Russian bathhouse. (Origin Russia)

Biosauna (or Soft Sauna)

A gentler, less extreme version of a Finnish sauna operating at 50° C to 60° C

Caldarium/Caldaria

The hottest room in ancient Roman baths and a precursor to today’s steam bath (Origin Latin)

Contrast Therapy

Refers to the therapeutic effects of hot and cold temperatures

Deluge Shower

Delivers a huge dump of cold water on bathers so they can cool between heat treatments.

Experience Showers

Multi-sensory shower experiences incorporating smell, sound and visual effects

Finnish Sauna

A wood structure with a heat source (wood-burning, electric or gas); the hottest and driest room in any spa, running at 80° C to 105° C

Floatation Bath

A warm bath containing oils or salts, where the client floats on the water, usually in the dark or in subdued lighting. A floatation tank is bed-sized and is a closed environment, often in total darkness.

Foot Spa

Specifically designed for bathing feet in cool or warm water in between hot treatments; feet play an important role in the heating and cooling process of the body due to the small amount of flesh and fat on them

Frigidarium/Frigidaria

The cold plunge pool in ancient Roman baths (Origin Latin)

Furo

A private bathing ritual in Japan that takes place in a bath made of wood; the furo is often found in private homes (Origin Japan)

Hamam

The word “hamam” literally translates to “bathroom” in Turkish and refers to the entire Turkish bathhouse. A Turkish hamam is a large domed structure with a central room (sıkaklek) in which the belly stone (göbek tasi) takes center stage. The belly stone is traditionally where attendants scrub and clean bathers. (Origin Turkish)

Hammam

A Moroccan hammam is similar to a Turkish bath but has retained more of the traditional Roman bathing ritual—sending the bather on a journey through smaller chambers with varying temperatures (like the Roman journey through the laconium, caldarium, frigidarium and tepidarium). (Origin Moroccan/N. African)

Hot Tub

Large tub or small pool of heated water used for hydrotherapy or pleasure. Some have jets for massage purposes. Hot tubs are sometimes known as spas or by the trade name Jacuzzi.

Hydrotherapy

The use of water for pain relief and treatment. The therapeutic effect of water depends on the temperature, depth and duration of immersion and its mineral content to soothe painful muscles and joints, as well as stimulate the circulation and immune system.

Hydrothermal Bathing

Pertaining to the temperature effects of water used in thermal cabins and pools

Ice Cave/igloo

Operating at 7° C to 15° C, these rooms provide contrast therapy to the hot rooms in a spa and mimic the traditional experience of a “roll in the snow.”

Ice Fountain

An access of ice in a spa for bathers to cool their bodies between hot treatments

Infrared Therapy

Using long-wave infrared radiation to distribute warmth through the peripheral nervous system

Inhalation Room

Specific treatment room for inhaling agents to treat respiratory conditions such as asthma, bronchitis and emphysema

Jacuzzi

Named after inventor and manufacturer, this is a bath or pool large enough for several persons sitting down to be massaged by underwater jets.

Kneipp Therapy

A 19th century adaptation of hydrotherapy formulated by Pastor Sebastian Kneipp (1821-1897) and consisting of hot and cold water treatments, walking barefoot in the morning dew, and the use of herbal bath oils, all combined with physical exercise and a diet of natural food. Popular in Austria, Germany and Switzerland.

Laconium

Name originates from Roman baths; this is a warm room (38-42 °C) where bathers can relax for long periods of time on benches or in individual, heated loungers or chairs. (Origin Latin)

Lap Pool

An exercise pool used for swimming lengths/laps and is commonly 25 m long x 12.5 m wide x 1.5 m deep. You can also find pools that offer both resistance and lap swimming in smaller spaces with the aid of motorized water-flow mechanisms.

Mineral Water

Water of natural purity used for bathing and/or drinking, the source of which has to be in a subterranean and protected water deposit. Mineral waters can have an acidic, basic or neutral pH, depending on the types of dissolved solids in the water. Depending on use, the content of some substances must not exceed the indicated limits.

Mud Bathing

Mud bathing originated thousands of years ago as a medicinal and beautifying ritual. The body is coated with organic thermal mud, and, depending on the minerals inherent in the mud, they can cleanse, exfoliate, absorb toxins, increase circulation and soften the skin.

Onsen

This pool type originates from Japan and has a significant role in the country's ritual bathing practices. "Onsen" translates as "hot springs" in Japanese and has come to refer to the natural spring baths found throughout Japan. Their benefits are closely dependent on the mineral properties and content of the water itself and typically include the easing of neuralgia, alleviation of muscle pain, the reduction of the symptoms of chronic skin disease and the relief of chronic fatigue and stress. (Origin Japan)

Pestemal

A pestemal (pesh-te-mahl) is the authentic Turkish bath towel. It is flat-woven with hand-tied fringe, typically made of Turkish cotton, linen or even silk. It is also known as a hamam towel, as it is an essential element of the legendary Turkish bath experience. Pestemals come in countless designs, textures, weights and colors. The hand-towel version of the pestemal is called a peskir (pesh-kir).

Plunge Pool

A cold plunge pool, also traditionally known as a frigidarium, is a cold-water pool that is typically entered after and between hot thermal treatments to cool bathers down.

Psammo therapy (sand bath)

Initially used in Ancient Egypt, sand baths are becoming popular in spas for their ability to help bathers relax both mentally and physically.

Refugium

The refugium is a relaxation area in a spa, typically smaller and more intimate than the tepidarium, and used for rest and sleeping.

Respiratory Therapy

The goal of respiratory therapy (also called inhalation therapy) is to improve respiration by steam inhalation combined with essential oils. There are specific treatments targeted at chronic conditions such as asthma, bronchitis and emphysema.

Salt Room/Cave

Salt therapy originated in Europe with natural salt caves and caverns. Claimed to relieve asthma, improve circulation and lower blood pressure, salt rooms and caves are specific treatment rooms requiring dry conditions, good ventilation and copious amounts of salt on the floor, walls and ceiling.

Sauna

There are several different styles of saunas in use today. The traditional and most common are Finnish saunas and Russian banyas; others include bio and infrared saunas. While various sauna types all run at slightly different temperatures and humidity, they are closely related in style, usage and health benefits.

Scotch Hose

An invigorating water jet massage that uses variable temperatures and pressure levels to stimulate circulation and relax muscles. Also known as the Scotch Hose Shower and Jet Blitz.

Sento

The Japanese developed a form of steam bath called the sento, a type of vapor bath that uses aromatherapy elements and includes body scrubbing. (Origin Japan)

Shower/Waterfall

Several shower options are available: cold waterfalls, mists, body jets and dramatic "experience showers" offering multi-sensory experiences that incorporate smells, sound and visual effects.

Snow Room

Cold rooms that use modern techniques to create real snow with which to cool the body. Operating at 1° C to 4° C, these rooms are becoming increasingly common in modern spas.

Spa Suite

A bedroom suite that offers additional spa equipment, such as a hot tub, treatment table, experience shower, etc.

Steam Bath/Room

The modern steam bath is unique in that it reaches 100% relative humidity—which gives it the element of steam/fog. The caldarium is the Roman precursor to the steam bath (also commonly called steam room).

Steam Shower

A steam shower is a type of bathing where a humidifying steam generator produces water vapor that is dispersed around a person's body. A steam shower is essentially a small steam room that offers the typical features of a bathroom shower, often with a seat for comfort.

Sudatorium

A type of steam room in a Roman bath where the high temperature promotes sweating.

Swiss Shower

A shower in which jets of water are sprayed onto the body from above, and also from numerous nozzles on the side.

Temazcal

The temazcal, or “sweat lodge,” is another example of thermal bathing. (Origin Mexico)

Tepidarium/Tepidaria

Relaxation spaces with loungers and beds; the Romans called these areas the tepidarium

Thalasso/Thalassotherapy

From the Greek word thalassa, meaning “sea,” it is the medical use of seawater as a form of therapy for preventive or curative purposes. The term includes seaweed, algae wraps and hydrotherapy.

Thermae/Therma

In Roman times, the thermae, from the Greek word thermos, meaning “hot,” were facilities for bathing; the term usually refers to the large public bathing complexes. Most Roman cities had at least one such

building, which were centers not only for bathing, but socializing. (Origin Latin)

Thermal Bathing

Thermal bathing is commonly associated with naturally hot water, rich in mineral salts, iodine and gases. The place is often referred to as a spa, which is traditionally used to mean a place where the water is believed to have special health-giving properties.

Thermal Suite

The collection of thermal treatments in a spa is commonly called the thermal suite.

Vichy Shower

A Vichy shower is a horizontal series of showerheads forming a “rain bar” over a waterproof, cushioned treatment table.

Vitality Pool

A vitality pool is the generic name for what people commonly refer to as a “Jacuzzi” (the brand name that has become synonymous with pools with water jets). Vitality pools offer a mini-hydrotherapy experience.

Water Cure

The use of water as a form of physical therapy, e.g., the Kneipp walk, which uses a mix of hot and cold water to stimulate the circulation of blood. Pebbles on the bottom of the stream/walkway massage the feet and the alternation of hot and cold baths stimulate circulation to all parts of the body.

Watsu®

These are pools designed specifically for Watsu massage, a gentle form of body therapy performed in warm water.

Whirlpool Tub

This is a bath large enough for several persons sitting down to be massaged by underwater jets.

Index

A

Americans with Disabilities Act (ADA) 45, 48, 162

Aquathermal 1, 175

Aquapressure 92

Aromatherapy 11, 15, 24, 26, 29, 65, 73, 87, 175

Arthritis 1, 5, 15, 16, 20, 23, 29, 56, 81, 99

Asthma 9, 19, 88, 107

B

Baden-Baden, Germany 5

Banya 2, 7, 18, 31, 49, 53, 175

Bath, England 4

Biosauna 49, 175

Blood

Circulation 12, 23, 54, 68, 81, 90, 92

Pressure 2, 9, 16, 19-21, 22, 24, 27, 75, 76, 81, 131, 177

Body scrub 3, 61, 128

Bronchitis 87, 177

Building Management System (BMS) 117, 154

C

Caldarium 7, 55, 175

Contrast therapy 16, 23, 50, 75, 81, 104, 175

D

Dead Sea 3, 88, 134

Deluge shower 11, 71

Disabled access 45, 48, 162

Dosing pump 73, 116

Drainage 118, 149-150, 160-161

Dry floatation bed 12, 38, 93-94

E

Electrical services 148-149

Emphysema 87, 176

Entries/exits 48

Epsom salts 11, 27, 106

Essential oils 7, 25-26, 67, 87, 147, 163, 175

Experience shower 10, 71-73

F

Finnish sauna 2, 7, 18-20, 24, 34, 49-54

Floatation pool 11, 105

Flooring 48

Foot spa 10, 74

Frigidarium 13, 23, 75-81

G

Geothermal 103, 121-133

German Sauna Standards 45

H

Hamam 3-4, 61-65

Health, safety & hygiene 159-165

Chemical room safety 115, 164

Construction 163

Design 160-161

Wet area hygiene 131

Risk assessment 165

Water safety 164

Hot springs 1, 102, 106, 121-133

Hydronic heating 63, 69

Hydrotherapy pool 100

Hydrotherapy medical evidence 14-23

Hydrotherapy tub 11, 91

Hygiene 4, 39, 45, 159, 161, 165

Hypertension 4

I

Ice fountain 13, 77

Immune system 2, 20, 50, 54, 104, 133

Infrared sauna 6, 22, 50, 54

Infrared therapy 176

Inhalation room 87-88

International Building Codes 45

J

Jacuzzi 9, 100, 172

Japan 3, 95, 102-103, 130-131, 175

K

Kelo log house sauna 6

Kneipp

Hose 58, 60, 67, 83

Walk 10, 71, 74, 107

Sebastian 10, 92

Therapy 92

L

Laconium 8, 41, 66-68, 176

Lap/exercise pool 99

M

Mexico 3, 178

Middle East 3, 95

Mineral pool 105-106

Mineral waters 106, 121, 128,

Morocco 3, 95

Mud bath 3, 9, 89, 176

Muscle pain 63, 106, 177

O

Onsen 3, 4, 98, 102-103, 130

Oxygen 83

P

People flow 36-37

Photo credits 182

Plant room 34, 36, 118

Plunge pool 5, 75-76, 98, 104, 150, 175

Pools 97

Chemicals 115, 117

Cleaning 111

Common mistakes 108

Construction 110

Design 108, 110

Disability access 109

Filtration 116

Lighting 119

Overflow vs freeboard 112-113

Saltwater 98, 110

Surface finishes 111

Water treatment 91-92, 96-97

Project planning 31

Assembling a project team 32

Commercial spa design, 32-34

Common mistakes 39

Key considerations 39

Specialist hydrothermal team 36

Public bathing 1, 2, 5, 63, 76, 178

R

Regenerative design 167

Relaxation room 66

Residential spa design 42-44

Respiratory therapy 87, 177

Return on investment 40-41

Risk assessment 165

Roman/Roman Empire 2, 5, 7, 8, 13, 15, 55, 61-63, 66-67, 69, 75

S

Salt 4, 9, 16, 27

Salt room 88, 177

Sauna 6, 45, 49-54

Health benefits 18-20

Sento 3, 177

Snow 2, 21, 23, 75

Making 77

Room 13, 75, 77, 177

Shower 13, 80

Spa suite 38, 83, 85, 177
Steam generators 56-57, 145, 171
Steam inlet 58
Steam rooms 7, 55, 177
Stress 19-20, 27-28, 55
Sudatorium 7, 55, 178
Sustainability 167

T

Temazcal 3, 178
Tepidarium 8, 69, 178
Thalassotherapy 4, 178
Thermae/therma 178
Treatment rooms 84-86
Turkish bath 3, 7, 61-62, 175

V

Ventilation/climate control 52,
59, 65, 79, 85, 87, 119, 144-147
Vichy shower 12, 83, 90, 178
Vitality pool 9, 100, 178

W

Watsu pool 12, 106, 129, 178
Whirlpool tub 178

Photo Credits

Thanks to all the companies and individuals who generously supplied us with the photography accompanying these pages. Where possible, photo credits are within the text, if not, readers can find them listed here.

Barr + Wray Ltd.: 3; 6 (top); 8 (bottom); 9 (bottom); 13 (top and bottom); 99; 100; 101; 113; 114

Dornbracht: 11 (top); 92 (bottom)

Faena Hotel, Miami Beach (Nik Koenig): 119 (right)

HygroMatik GmbH CSA: 7 (middle); 55

Iso Benessere: 82

Kemitron GmbH: 10 (middle)

Klafs GmbH & Co. KG: 6 (bottom); 7; 88; 154; 155

Lux Elements GmbH: 139-143

SnowBOX: 13 (bottom middle)

Sommerhuber: 8 (top); 9 (middle); 160

TechnoAlpin: 11 (top middle)

Tschuggen Hotel Group, Switzerland: 10

Unbescheiden GmbH: 11 (middle); 12 (all)

WDT Werner Dosiertechnik GmbH & Co. KG: 10 (middle)

A special thanks to all the knowledgeable hydrothermal experts at the following companies:

absolute-pools: www.absolute-pools.com

Bringing pools to life through innovation, good design and industry best practice

Barr + Wray Ltd.: www.barrandwray.com

Spa interior design, engineering consultancy; and pool and thermal installation and maintenance

Design For Leisure Ltd.: www.designforleisure.com

Hydrothermal spa design consultants and implementation specialists

Dornbracht: www.dornbracht.com

Leading high-end manufacturer of bathroom fixtures

Gharieni Group: www.gharieni.com

German manufacturer of high-end spa tables and equipment

Hilton Worldwide: www.hiltonworldwide.com

One of the largest hospitality companies in the world

HygroMatik GmbH: www.hygromatik.de

A leading manufacturer of professional humidifiers and steam bath generators

Klafs GmbH & Co.: www.klafs.com

A market leader for sauna, spa and wellness with over 80 years experience

Kemitron GmbH: www.kemitron.com

Producer of fragrance, cosmetics, dosing pumps and process control systems for the spa and wellness industry

Lux Elements GmbH: www.luxelements.com

Specialist in producing hard foam, ready-to-tile, shaped elements for spa facilities

Six Senses Hotels Resorts Spas: www.sixsenses.com

Offering a layered approach that unites a pioneering spirit with treatments that go beyond ordinary

SnowBOX GmbH: www.snowbox.info

Snowmaking technology for event, spa & industry

Sommerhuber: www.sommerhuber.com

Manufacturer of large-area heat storage ceramics focused on design and hygiene

TechnoAlpin: www.technoalpin.com

Snow room and indoor snow installations

Unbescheiden GmbH: www.unbescheiden.com

Manufacturer of spa and hydrotherapy equipment since 1869

WDT Werner Dosiertechnik GmbH & Co. KG: www.werner-dosierttechnik.de

Control and dosing systems for swimming pools and wellness facilities



**GLOBAL WELLNESS
INSTITUTE™**
EMPOWERING WELLNESS WORLDWIDE

**Global Wellness Institute
333 S.E. 2nd Avenue, Suite 3750
Miami, FL 33131 United States**

www.globalwellnessinstitute.org